

MD380

Inline 3D Distortion Measurement

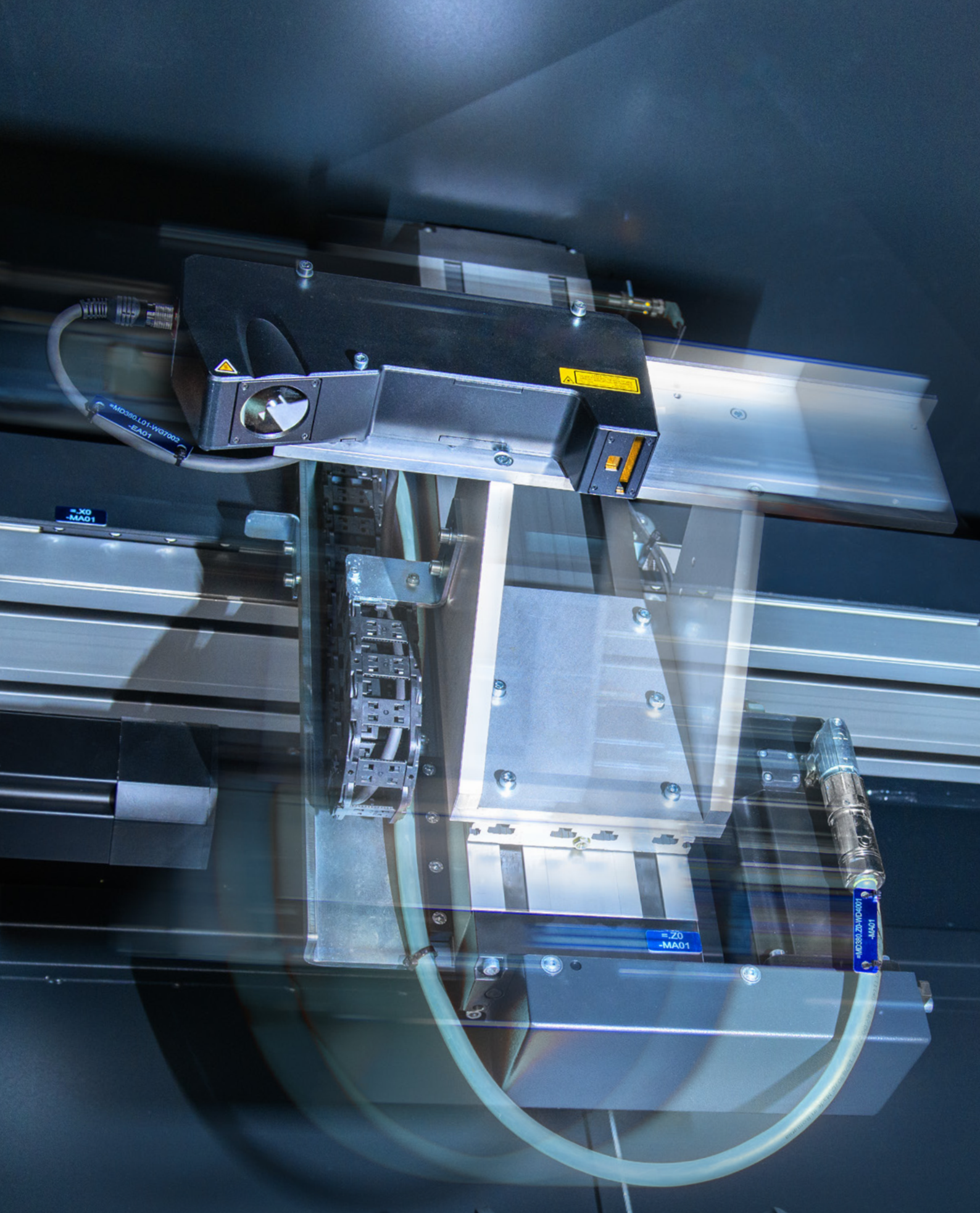



Quality analyses based on 3D measurement data in real time directly from the ongoing production process

MD380

Inline 3D Distortion Measurement

Fully integrated 3D laser measurement technology makes it possible to analyze aluminum raw cast wheels directly in the production flow and to incorporate findings directly into the casting process.

The MD380 3D distortion measuring machine creates a complete three-dimensional copy of the design side of a raw casted wheel. The resolution achieved and the associated level of detail provide information about the mold condition or process errors in addition to the possibility of distortion analyses. The brand new MD380 can be used to measure and evaluate deviations in the shape of spokes and detect deformations on the clamping rim. It also checks whether the sprue point has been removed or whether spoke widths have changed unnaturally. These are just a few of the options available with 3D measurement using the MD380.

The space-saving and low-maintenance inline design makes it possible to retrofit the MD380 into almost any existing production line. Only three conventional straight roller table segments are required. The wheel ID is transferred from the roller table control to the MD380. As soon as the wheel has been fed into the machine, it is centered and the pre-positioned high-resolution line sensor begins the scanning process. Immediately after the scan has been completed, the measured wheel and the following wheel are conveyed in and out in parallel.

Depending on the required analysis capabilities of the MD380, corresponding evaluations are calculated and graphically processed on one or optionally two measuring computers during the wheel exchange. Customer-specific OK/NOK criteria can be defined to remove rejected wheels directly from the process.

YOUR ADVANTAGES

» Complete 3D analysis of the wheel design

Complete 3D image of the design side can be used individually for analyses:
Distortion, clamping rim control, spoke deformations, sprue point control

» Random production

Possible due to wheel-specific measuring programs; no changeover of the machine necessary

» Trend analysis

Trend analyses of the casting and heat treatment process can be displayed for production monitoring using the data stored in the system.

» Cost savings and increased capacity

Early ejection of NOK wheels means that no unnecessary work steps are carried out on NOK wheels, freeing up capacity on subsequent machines.

ANALYSIS FUNCTIONS

Standard measurements



Clamping rim

- » Diameter check
- » Roundness analysis
- » Flatness measurement



Cap area

- » Height check of the wheel hub area
- » Flatness measurement (determination from max. 8 measuring points)



Hub deviation

- » Flatness analysis between clamping rim and hub area (max. 12 points)
- » Mold-specific trend analysis of the distortion



Sprue point

- » Check whether sprue point is existing or not (OK/NOK output possible)
- » Height measurement of the sprue point
(averaging of individual measured values)

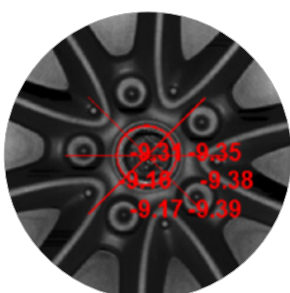

Single point measurement

- » Customized height measurement of individual points
(without wheel orientation)
- » Mold-related measuring point evaluation

ANALYSIS FUNCTIONS

Rotation dependent measurements

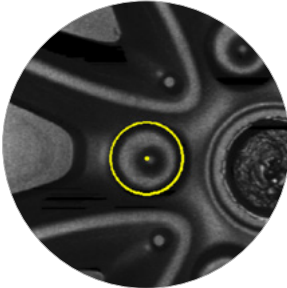

Valve hole orientation

- » Valve model recognition
- » Bolt hole design recognition
- » Wheel symmetry check



Distortion measurement

- » Minimum and maximum distortion
- » Best fit support point determination
- » Rotational position determination of support jaws
- » 360° diagram of the clamping rim

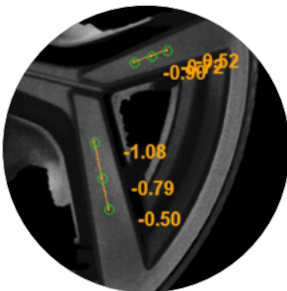

Spoke distortion

- » Three spokes, each with three freely selectable measuring points
- » Measurement of the height and automatic evaluation of the quality of the selected measuring point
- » Output of the measuring angle of each selected point



Residual flash detection

- » Detection of casting flags or flashes on the clamping rim
- » Evaluation of the size of the detected anomaly
- » Position of the detected anomaly in relation to the valve model (angle)



Single point measurement

- » Several customized points freely selectable on the wheel and aligned with the valve model
- » Repeatable height measurement of the individually selected measuring points



- ① Laser unit
- ② Touch panel
- ③ Maintenance doors
- ④ Centering unit
- ⑤ Control cabinet

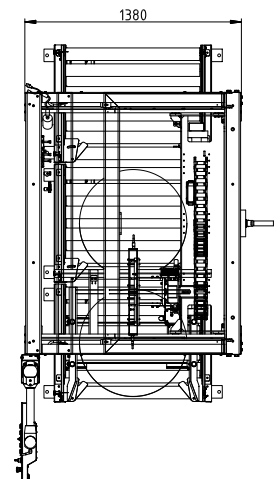
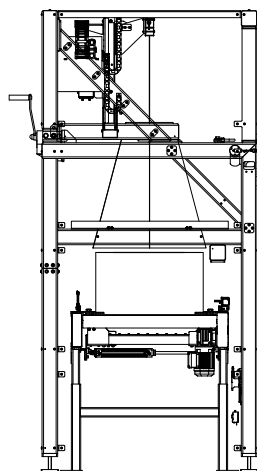
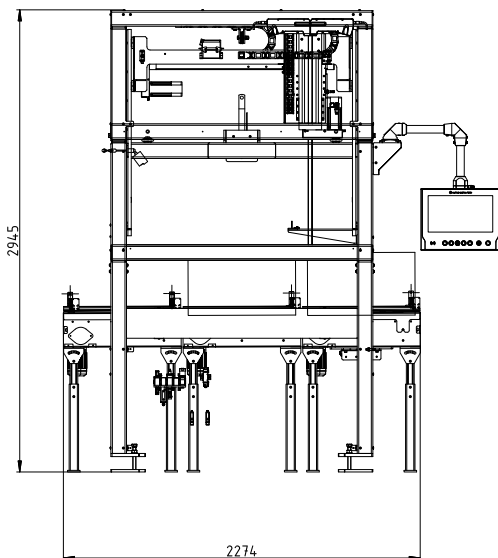
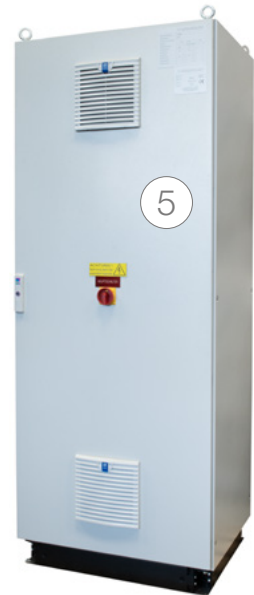

TECHNICAL DATA

Machine features	measurement principle	light-section line laser
	measurement characteristics	clamping rim cap area hub deviation sprue point single point measurement barcode reading (option)
	rotation dependent measurement features (optional)	valve hole orientation distortion measurement spoke distortion residual flash detection single point measurement
	measurement positions	complete wheel design and spoke surfaces towards the design side
	measuring range laser sensor	approx. 400 mm in Z-direction approx. 600 mm in X-direction
Wheel parameters	wheel size	15 – 24"
	wheel weight	max. 45 kg
	surface requirements at the clamping rim	flat, > 80° to the beam direction of the laser sensor clamping rim designed according to the standard and of sufficient width
Performance characteristics	repeatability of the measurement	To determine the repeatability, the AMT test part is measured 50 times in rapid succession with the same machine at the same location without moving the test part. The maximum deviation of the repetitions is $\pm 300 \mu\text{m}$.
	machine capacity	approx. 12 sec for an 18" wheel (optionally 6 sec with 2 nd PC)
Technical components	barcode scanner system	NUMTEC BCU700 (option)
	HMI	18,5" touch display
	control system	industrial PC
	wheel type recognition	NUMTEC barcode system incl. turning device (option)
	centering	15" – 24"
	flow forming wheels	optional
Interfaces		Profibus, Profinet, Parallel I/O Ethernet for data transmission and remote maintenance
Media	electric connection	3 x 400 VAC $\pm 5\%$ or 50 Hz $\pm 2\%$ TN-C-S system power consumption max. 5 kVA optional 3 x 460 VAC, 60 Hz, 5 kVA
	pneumatic connection	compressed air quality class 3 according to DIN ISO 8573-1 max. particle size 5 μm max. particle density 5 mg/m ³ residual oil content 5 mg/m ³ at least 6 bar
	ambient temperature	working area 15 - 40°C
Machine dimensions	L x W x H	2.274 x 1.380 x 2.945 mm
Weight		approx. 1.200 kg

FEATURES



NUMTEC laser unit

Maximum measurement quality can be achieved by using optimized laser sensors, axis portals and high-precision production parts, paired with specially developed evaluation algorithms.



Modular design

A special frame concept enables easy adaptation of the frame heights and integration into any production environment. The lowerable measuring axis simplifies maintenance and servicing of the laser unit.



Networkable software

Intuitive teach-in of new wheel types by using a specially developed software. The measurement results can be directly linked to each wheel in the database using DMC and can be networked with other systems.

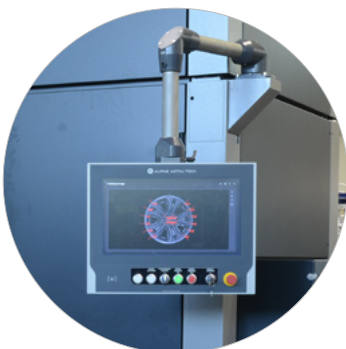

Swivel-mounted touch panel

The touch panel is equipped with a robust yet sensitive surface. The swivel-mounted control unit allows optimal manipulation in all operating states.



Live image camera

Thanks to the live image camera, the measuring process can be conveniently observed and the teaching of new wheels can be checked visually.



Operating concept

Intuitive machine operation thanks to clear menu navigation. Detailed additional descriptions for submenus are also integrated.



Wheel centering

Wheel centering is essential for the measuring process. The integrated unit offers the ideal compromise between precision, robustness and speed.



Maintenance

To simplify maintenance, the entire measuring unit can be lowered so that all essential components can be reached quickly and safely.



Alpine Metal Tech GmbH
Buchbergstraße 11
4844 Regau, Austria
Tel.: +43 7672 78134-0
E-Mail: office@alpinemetaltech.com
Web: www.alpinemetaltech.com

