

GM100

Geometric inline profile testing

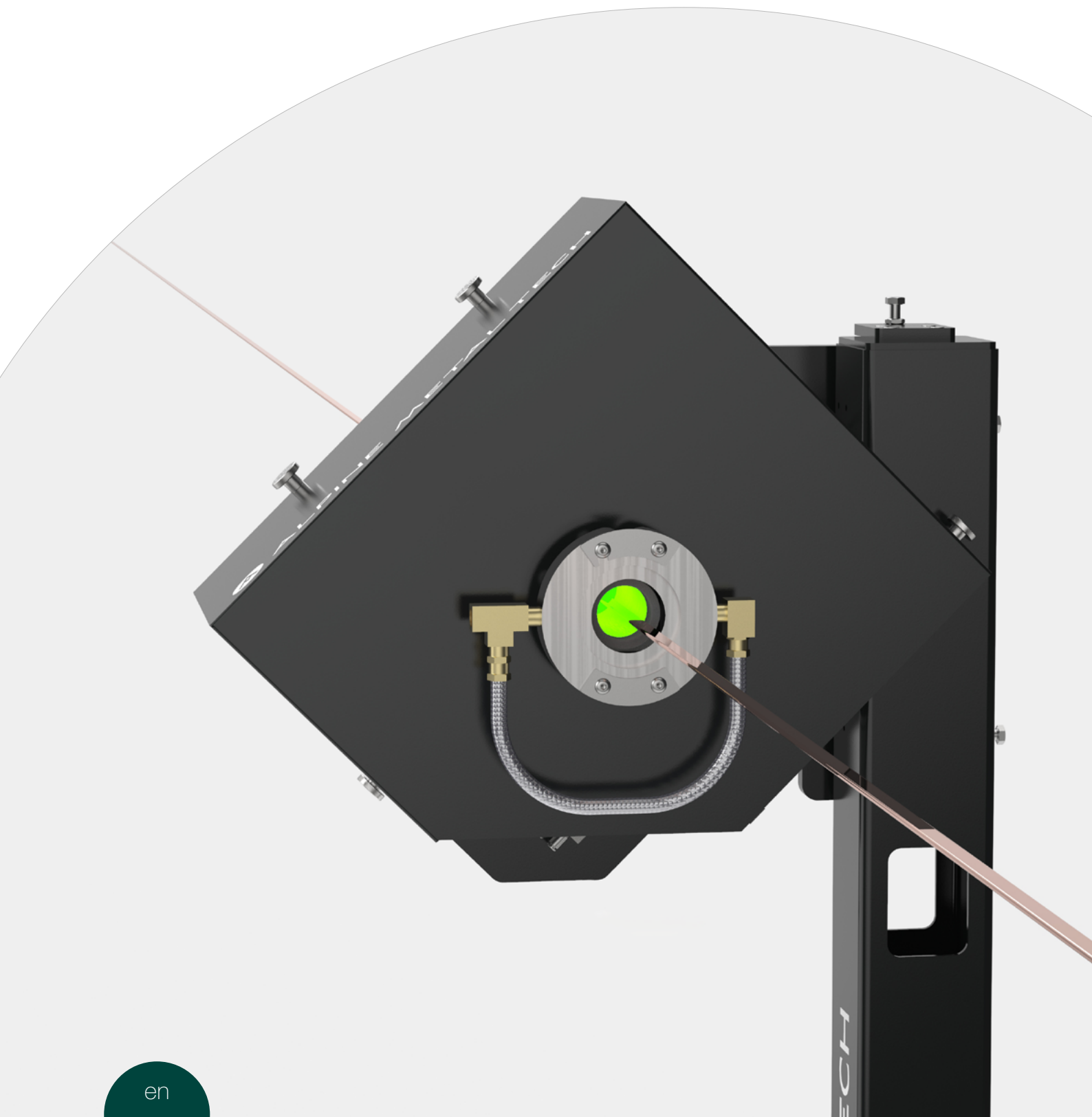

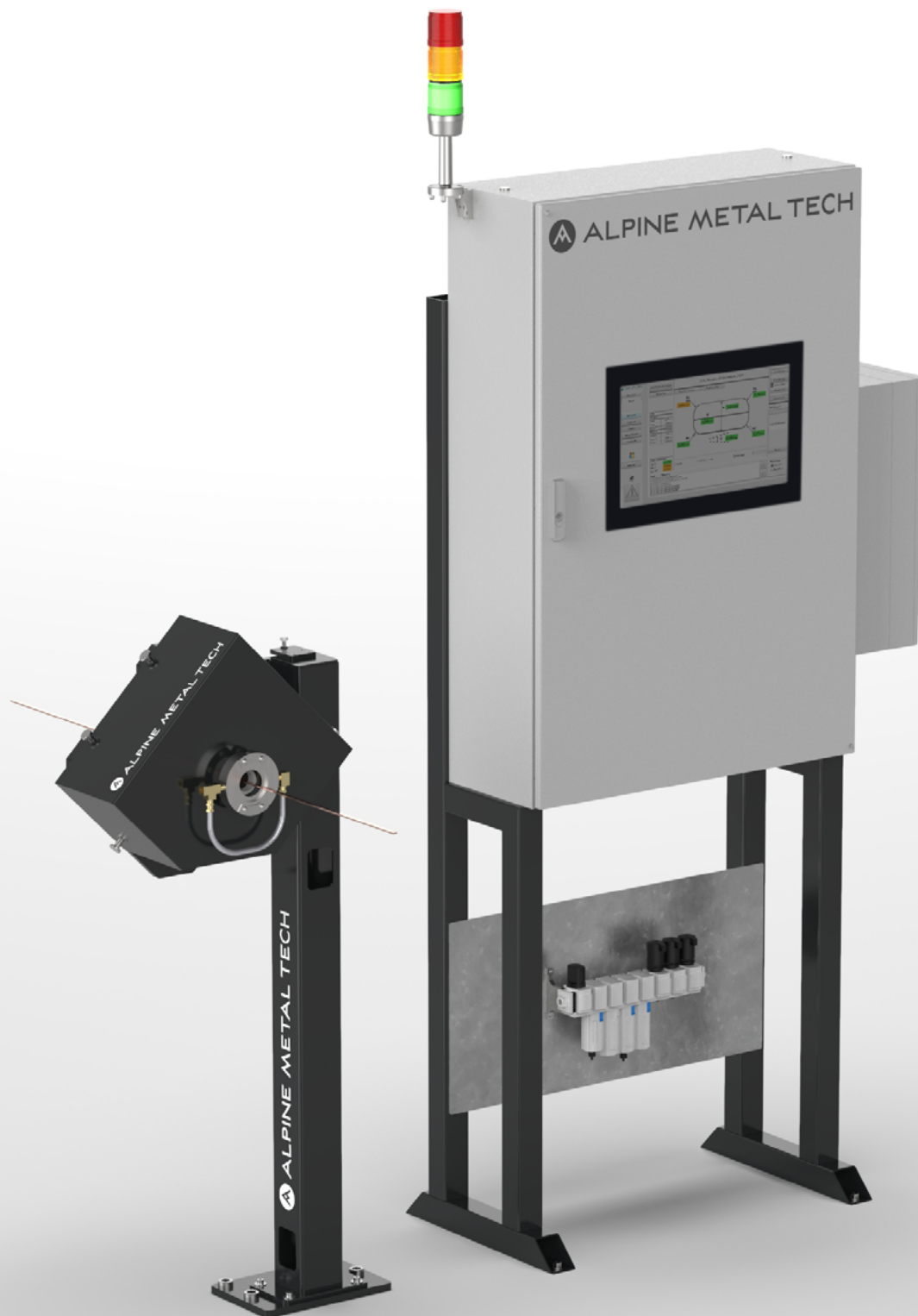

Testing system for analysing geometric features during running production

GM100

Geometric inline profile testing

The GM100 inline wire testing system uses integrated laser measurement technology to analyse all geometric features directly in the production flow.

Inside the machine, four high-precision line sensors and two fibre-optic micrometers are installed around the running wire. At full production speed, all geometric features such as wire width, wire thickness, radius quality and parallelism are measured and checked with tight tolerances up to ± 0.01 mm. Different wire types can be set on the GM100 control unit. In addition, it is possible to perform

single measurements when setting up the rolling mill, eliminating the need for time-consuming manual laboratory testing and thus enabling the wire dimension to be changed quickly.

The detected geometry errors are visualised on the screen of the measuring unit and the analysis data is then forwarded to optimize the production process. In addition, it is ensured that the wire is produced within the tolerances. The evaluation can be stored in the customer database for documentation purposes.

Inline wire testing can drastically reduce set-up times and rejects, thereby significantly increasing production capacity.

YOUR ADVANTAGES

» Measuring system for various applications

- Geometry measurement, angularity
- Profile measurement
- Thickness and width measurement
- Contour control (radius, angle, shape)
- Early detection of roller wear

» Optimising production

Analysing the data can be used to eliminate the causes of manufacturing errors.

» Reduction of rejects and set-up times

The defective wires can be sorted out before expensive downstream processes and detected at an early stage. This increases productivity and the value of the recycled material.

» Set-up time minimisation

Long free-running processes with laboratory measurements can be recorded directly on the system at the touch of a button.

FEATURES

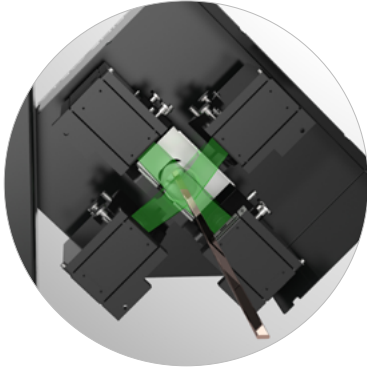

Profile measurement

Four line sensors arranged around the running wire provide a 360° image of the wire. Contour deviations in width and thickness as well as changes in radius, angle and shape can therefore be reliably detected.

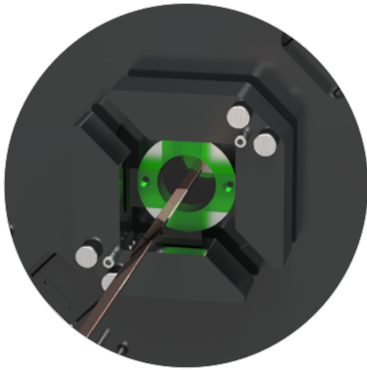

Thickness and width measurement

The two light band micrometers are arranged at 90° to each other and are used to measure the width and thickness of the wire.



Laser bracket

Solid bracket for mounting the four laser sensors, including protective cover. The bracket can be customised to suit the existing machine environment.



Operating unit

The operating unit is integrated into the control cabinet as standard, but can also be positioned directly at the measuring station or extended to include an additional operator panel. The control cabinet contains all the necessary controllers and components.

The measurement protocols can be transferred to the customer database via a network connection. It is also possible to export the data to a PDF report or an Excel table.

SHAPE DEVIATIONS

The GM100 detects form deviations such as radiuses, angles and parallelism.
Drawings of possible defects are shown below.

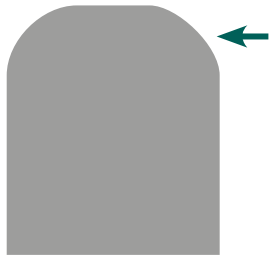

Sample wire 1

Type of defect: radius profile, parallelism
Radius is misshapen, not rolled out

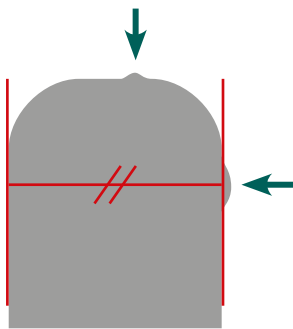

Sample wire 2

Type of defect: shape deviation
Excess material

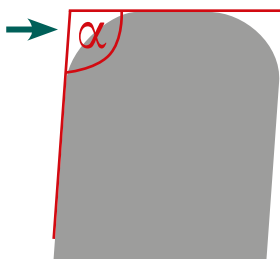

Sample wire 3

Type of defect: flat-edge geometry, radius deviation
Angular deviation between top edge and side edge

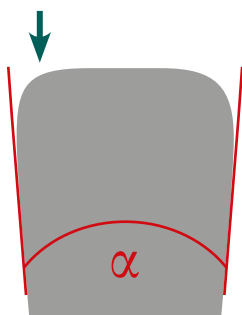

Sample wire 4

Type of defect: radius profile, lat-edge geometry
Radius is angular, side edges are not parallel

SOFTWARE

Statistical evaluation

Messung	Nominal	Grenze	Wert	Einheit	Balkenvisualisierung
Draht	4,000	4,040 <-> 4,000	4,042	mm	<div style="width: 100%; height: 10px; background-color: yellow;"></div>
Höhe	1,210	1,190 <-> 1,210	1,200	mm	<div style="width: 100%; height: 10px; background-color: green;"></div>
Radius 1	0,50	0,45 <-> 0,55	0,45	mm	<div style="width: 100%; height: 10px; background-color: yellow;"></div>
Radius 2	0,20	0,25 <-> 0,35	0,30	mm	<div style="width: 100%; height: 10px; background-color: green;"></div>
Radius 3	0,20	0,25 <-> 0,35	0,28	mm	<div style="width: 100%; height: 10px; background-color: green;"></div>
Radius 4	0,50	0,45 <-> 0,55	0,49	mm	<div style="width: 100%; height: 10px; background-color: green;"></div>
Winkel	0,0	-1,0 <-> 1,0	-0,1	deg	<div style="width: 100%; height: 10px; background-color: green;"></div>

The display is used to analyze a wire after the measurement has been completed. It consists of the overview, quality and diagram sections. The nominal limits are shown for each measured value. The deviation is indicated in colour in a bar chart.

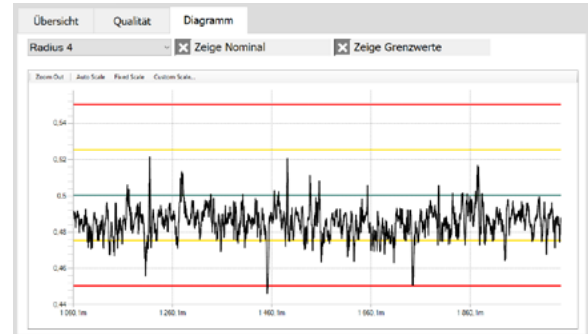

Ongoing production can be visually monitored. The red lines indicate the NOK limits. The yellow lines visualise the adjustable limit values (a warning is displayed within the values).

Geometric defect visualisation

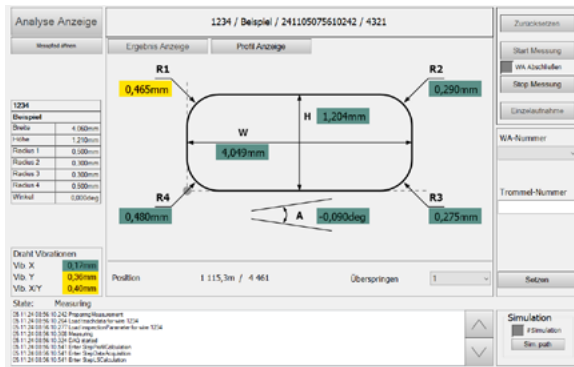

The results screen illustrates the current measured values and calculation results in a schematic drawing. The colours green, yellow and red visualize the positions within specified warning and alarm limits.

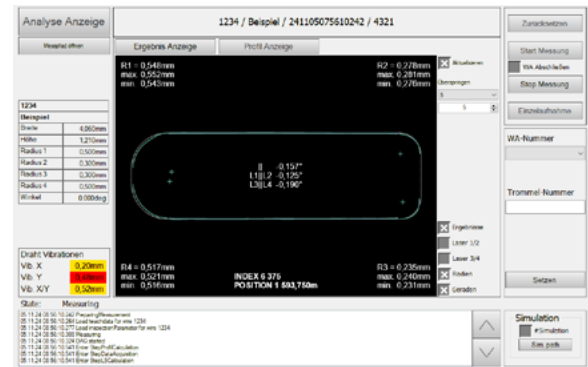

The profile display shows the profile shape of the wire as well as some details for calculating the radiuses and angles.

TECHNICAL DATA

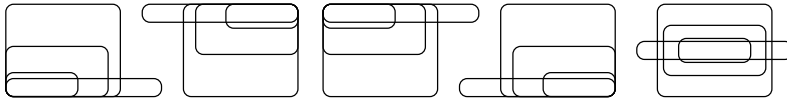
Machine type	geometric inline wire testing with laser sensors
Measurement characteristics	<p>geometry measurement, angularity</p> <p>profile measurement</p> <p>thickness and width measurement</p> <p>contour control (radius, angle, shape)</p> <p>early detection of roller wear</p>
Wire	<p>material: copper, aluminium, or others</p> <p>dry, grease-free, unpainted</p> <p>wire width: 2.0 mm – 25.0 mm</p> <p>wire thickness: 0.5 mm – 10.0 mm</p> <p>radiuses: 0.3 mm – 1.25 mm (other dimensions available on request)</p>
Possible wire structure in the machine	
Tolerances	<p>wire width: ± 0.010 mm</p> <p>wire thickness: ± 0.010 mm</p> <p>angle: $\pm 2^\circ$</p> <p>radius: ± 0.025 mm</p>
Scanning rate measurement	<p>determined by means of feasibility analysis in the field test</p> <p>geometry measurement: approx. 10 m</p> <p>thickness/width measurement: 250 mm</p>
Laser arrangement	To ensure optimum measurement accuracy, the laser arrangement is selected and customised according to the wire dimensions.
Transport speed	min. 20 m/min; max. 400 – 600 m/min (higher speed on request)
Control system	industrial PC

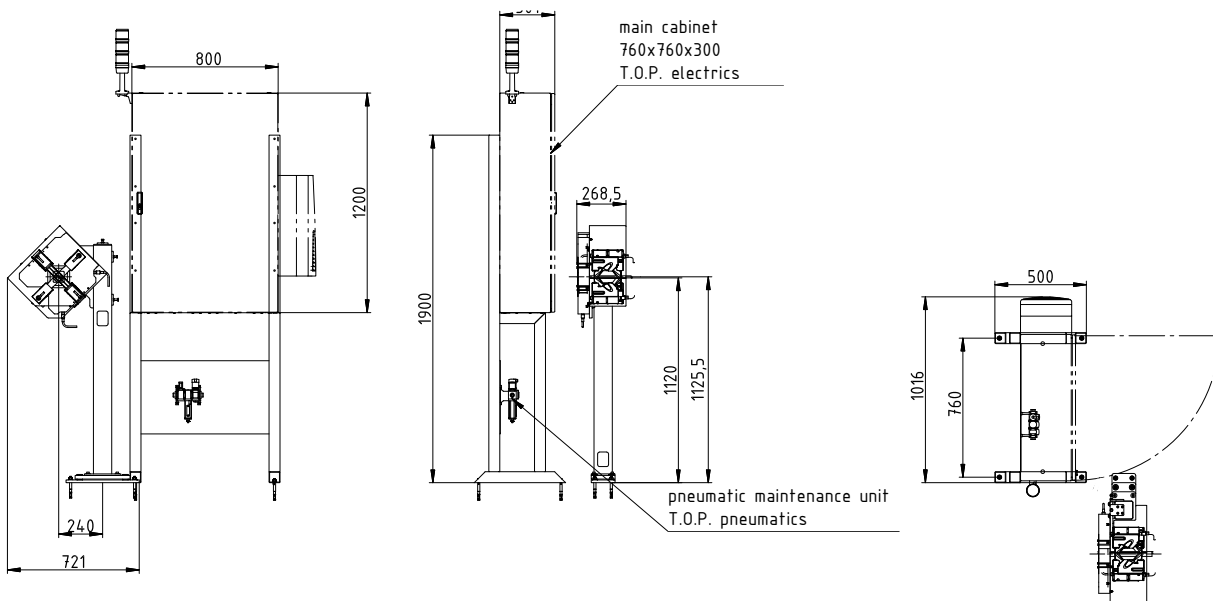

Alpine Metal Tech GmbH
Buchbergstraße 11
4844 Regau, Austria
Tel.: +43 7672 78134-0
E-Mail: office@alpinemetaltech.com
Web: www.alpinemetaltech.com

