

PRODUCT CATALOGUE

Autogenous technology for steel



NOZZLES

SDS F
SDS FP
SDS FB
SHEL F
HOT
STD
SD3 HSO
HFD 1F
MBR

SDS F NOZZLES

The SDS F series includes the most successful cutting nozzles of the AMT group. They impress with their high reliability and low media consumption in daily use in steel works. The high nozzle distance above the slab guarantees low wear and subsequently longer life span.



CUTTING THICKNESS RANGE

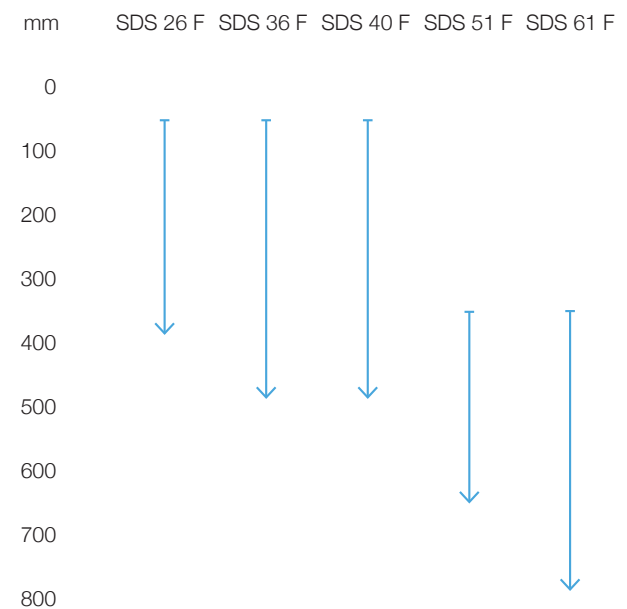

MAIN CHARACTERISTICS

Nozzle distance range	120 mm – 165 mm
Oxygen pressure range	8 – 15 bar
Gas pressure range	0.6 – 2 bar

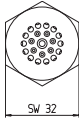
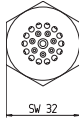
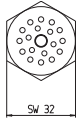
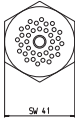
	SDS 26 F	SDS 36 F	SDS 40 F	SDS 51 F	SDS 61 F
					
ITEM NO.	108183	106567	108187	108188	111951
CUTTING THICKNESS RANGE (mm)	50-400	50-500	50-500	350-650	350-800
NOZZLE DISTANCE (mm)	120-165	120-165	120-165	120-165	120-165
CONSUMPTION (Nm³/h)					
Heating oxygen flow by natural gas	19	19	19	12	24
Gas flow by natural gas	21	21	21	25	36
Heating oxygen flow by propan gas	19	19	19	12	24
Gas flow by propan gas	9	9	9	10	14
Heating oxygen flow by coke oven gas	22	22	22	17	31
Gas flow by coke oven gas	31	31	31	30	42
Cutting oxygen flow	52	58	64	84	124
PRESSURE CUTTING (bar)					
Heating oxygen pressure by natural gas	2.5	2.5	2.5	1.7	2.2
Gas pressure by natural gas	1.5	1.5	1.5	1.4	1.3
Heating oxygen pressure by propan gas	2.5	2.5	2.5	1.7	2.2
Gas pressure by propan gas	0.8	0.8	0.8	0.7	0.6
Heating oxygen pressure by coke oven gas	3	3	3	1.9	2.8
Gas pressure by coke oven gas	2	2	2	1.5	1.8
Cutting oxygen pressure	15	10	9	8	9
APPLICABLE CUTTING TORCHES					
SBK 500 F	+	+	+	+	
SB 500 F	+	+	+	+	
SB 800 F					+
SHBA - M F	+	+	+	+	
SHBS - M F	+	+	+	+	
SHBS - MS F	+	+	+	+	
SHBA - MS F	+	+	+	+	
SPANNER WIDTH	SW 32	SW 32	SW 32	SW 32	SW 41

SDS FP NOZZLES

In the autogenous cutting process, conventional cutting technology reaches its limit with certain alloy compositions. This is where the AMT Gega SDS FP nozzle series comes into play.

Combined with an AMT Gega powder system, this generation of nozzles succeeds in significantly expanding the limits of what is possible in alloy cutting. By adjusting the heating performance, an optimum powder flow is achieved.



CUTTING THICKNESS RANGE

mm	SDS 26 FP	SDS 36 FP	SDS 40 FP
0			
100			
200			
300			
400	↓		
500		↓	↓
600			
700			
800			

MAIN CHARACTERISTICS

Nozzle distance range	80 mm – 120 mm
Oxygen pressure range	9 – 15 bar
Gas pressure range	0.5 – 1.4 bar

SDS 26 FP

SDS 36 FP

SDS 40 FP



ITEM NO.	108189	108191	106556
CUTTING THICKNESS RANGE (mm)	50 - 400	50 - 500	50 - 500
NOZZLE DISTANCE (mm)	80 - 120	80 - 120	80 - 120
CONSUMPTION (Nm³/h)			
Heating oxygen flow by natural gas	14	14	14
Gas flow by natural gas	20	20	20
Heating oxygen flow by propan gas	14	14	14
Gas flow by propan gas	8	8	8
Heating oxygen flow by coke oven gas	17	17	17
Gas flow by coke oven gas	25	25	25
Cutting oxygen flow	52	58	64
PRESSURE CUTTING (bar)			
Heating oxygen pressure by natural gas	1.8	1.8	1.8
Gas pressure by natural gas	1.1	1.1	1.1
Heating oxygen pressure by propan gas	1.8	1.8	1.8
Gas pressure by propan gas	0.5	0.5	0.5
Heating oxygen pressure by coke oven gas	2.3	2.3	2.3
Gas pressure by coke oven gas	1.4	1.4	1.4
Cutting oxygen pressure	15	10	9
APPLICABLE CUTTING TORCHES			
SBK 500 F	+	+	+
SB 500 F	+	+	+
SHBA - M F	+	+	+
SHBS - M F	+	+	+
SHBS - MS F	+	+	+
SHBA - MS F	+	+	+
SPANNER WIDTH	SW 32	SW 32	SW 32

SDS FB NOZZLES

The SDS FB series is a special application for plate cutting within the SDS family. Cut material thicknesses of 10 to 220 millimetres optimally with this distinct cutting nozzle. By adjusting the pre-heating, edge melting on the cutting surface is reduced.



CUTTING THICKNESS RANGE

mm	SDS 18 FB	SDS 23 FB	SDS 30 FB
0	↓		
100		↓	
200			↓
300			
400			
500			
600			
700			
800			

MAIN CHARACTERISTICS

Nozzle distance range	10mm – 15mm
Oxygen pressure range	4 – 11 bar
Gas pressure range	0.1 – 0.6bar

SDS 18 FB

SDS 23 FB

SDS 30 FB

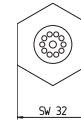
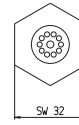
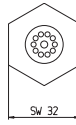

ITEM NO.	110476	109421	110477
CUTTING THICKNESS RANGE (mm)	10 – 40	40 – 150	140 – 220
NOZZLE DISTANCE (mm)	10 – 15	10 – 15	10 – 15
CONSUMPTION (Nm³/h)			
Heating oxygen flow by natural gas	3.9	3.9 – 7	3.4 – 5.1
Gas flow by natural gas	3.4	3.4 – 10	4.1 – 9.3
Cutting oxygen flow	6.8 – 8	14.6 – 25	24.4 – 39.1
PRESSURE CUTTING (bar)			
Heating oxygen pressure by natural gas	0.3	0.3 – 0.8	0.3 – 0.7
Gas pressure by natural gas	0.1	0.1 – 0.6	0.1 – 0.5
Cutting oxygen pressure	4 – 7	6 – 11	6 – 10
APPLICABLE CUTTING TORCHES			
SBK 500 F	+	+	+
SB 500 F	+	+	+
SPANNER WIDTH	SW 32	SW 32	SW 32

SHEL F NOZZLES

The latest evolutionary stage in the AMT Gega nozzle series. Patented with quick cutting processes in the concast section in mind, for when the material is still hot. Significantly increased cutting speeds allow shorter cut zones with reduced fuel gas consumption and narrower cutting kerfs.

Engineered to meet increasingly stringent safety regulations in steel works, this nozzle series guarantees a high model-related safety standard due to its application of post mix technology. The shrouded design offers the additional the advantage of lower noise emissions and an extended lifespan.

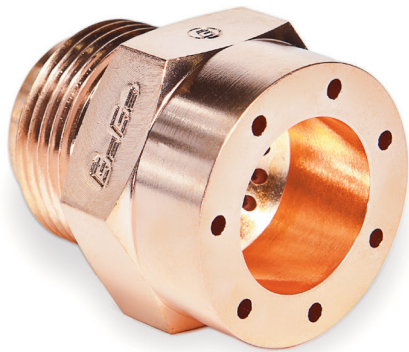

CUTTING THICKNESS RANGE

mm	SHEL 32 F	SHEL 35 F
0		
100	↓	
200		
300		↓
400		
500		
600		
700		
800		

MAIN CHARACTERISTICS

Nozzle distance range	120 mm – 165 mm
Oxygen pressure range	10 – 12 bar
Gas pressure range	0.8 – 2 bar

SHEL 32 F

SHEL 35 F

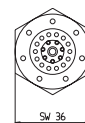
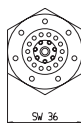

ITEM NO.	111893	111892
CUTTING THICKNESS RANGE (mm)	50 – 250	50 – 350
NOZZLE DISTANCE (mm)	120 – 165	120 – 165
CONSUMPTION (Nm³/h)		
Heating oxygen flow by natural gas	22	22
Gas flow by natural gas	17	17
Heating oxygen flow by propan gas	22	22
Gas flow by propan gas	7.5	7.5
Heating oxygen flow by coke oven gas	25	25
Gas flow by coke oven gas	23	23
Cutting oxygen flow	53	53
PRESSURE CUTTING (bar)		
Heating oxygen pressure by natural gas	2.5	2.5
Gas pressure by natural gas	1.5	1.5
Heating oxygen pressure by propan gas	2.5	2.5
Gas pressure by propan gas	0.8	0.8
Heating oxygen pressure by coke oven gas	3	3
Gas pressure by coke oven gas	2	2
Cutting oxygen pressure	12	10
APPLICABLE CUTTING TORCHES		
SBK 500 F	+	+
SB 500 F	+	+
SHBA - M F	+	+
SHBS - M F	+	+
SHBS - MS F	+	+
SHBA - MS F	+	+
SPANNER WIDTH	SW 36	SW 36

HOT NOZZLES

This unique high-pressure oxygen series was specially developed for quick separation of the steel products from the strand and for high productivity during secondary slitting and sub-dividing operations. With regards to the crucial factor of cutting speed, the patented AMT Gega HOT nozzle assumes a leading role in global comparison, enabling significantly shortened work cycles.

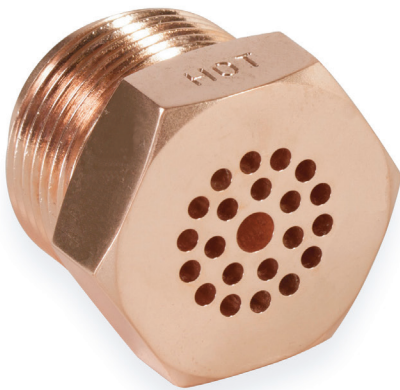

CUTTING THICKNESS RANGE

mm	HOT 26 1S	HOT 30 1S
0		
100		
200		
300		
400		
500		
600		
700		
800		

MAIN CHARACTERISTICS

Nozzle distance range	120 mm – 165 mm
Oxygen pressure range	27 – 30.5 bar
Gas pressure range	0.8 – 2 bar

HOT 26 1S

HOT 30 1S

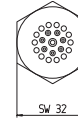
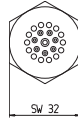

ITEM NO.	108172	108173
CUTTING THICKNESS RANGE (mm)	100 – 300	100 – 300
NOZZLE DISTANCE (mm)	120 – 165	120 – 165
CONSUMPTION (Nm³/h)		
Heating oxygen flow by natural gas	19	19
Gas flow by natural gas	21	21
Heating oxygen flow by propan gas	19	19
Gas flow by propan gas	9	9
Heating oxygen flow by coke oven gas	22	22
Gas flow by coke oven gas	31	31
Cutting oxygen flow	58	74
PRESSURE CUTTING (bar)		
Heating oxygen pressure by natural gas	2.5	2.5
Gas pressure by natural gas	1.5	1.5
Heating oxygen pressure by propan gas	2.5	2.5
Gas pressure by propan gas	0.8	0.8
Heating oxygen pressure by coke oven gas	3	3
Gas pressure by coke oven gas	2	2
Cutting oxygen pressure	27	30.5
APPLICABLE CUTTING TORCHES		
HOBS 1S	+	+
SPANNER WIDTH	SW 32	SW 32

STD NOZZLES

This conically sealing thick cutting nozzle is constructed for cutting thicknesses up to two metres. Due to its long, slim geometry, media turbulence is reduced, enabling precise cutting of high strength material.

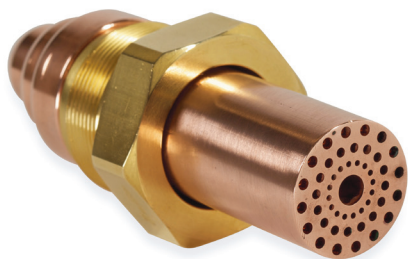

CUTTING THICKNESS RANGE

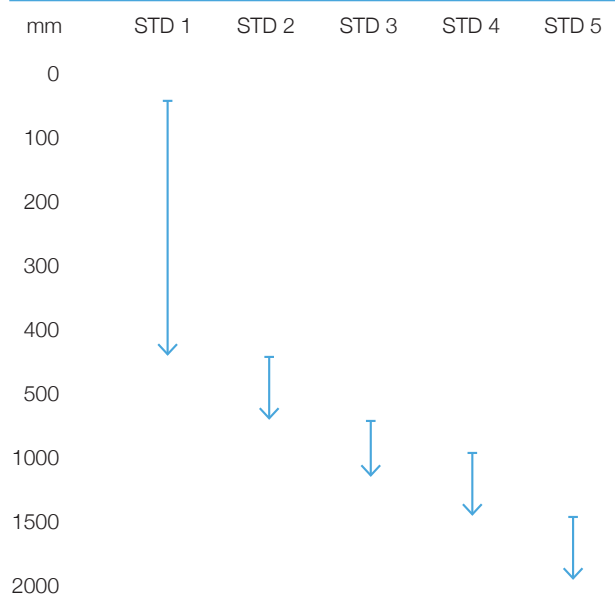

MAIN CHARACTERISTICS

Nozzle distance range	50 mm – 180 mm
Oxygen pressure range	5 – 10 bar
Gas pressure range	0.1 – 2 bar

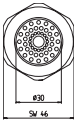
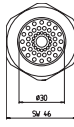
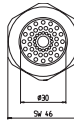
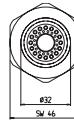
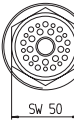
	STD 1	STD 2	STD 3	STD 4	STD 5
					
ITEM NO.	108284	108285	108286	108287	114181
CUTTING THICKNESS RANGE (mm)	50 – 450	450 – 750	750 – 1200	1000 – 1200	1500 – 2000
NOZZLE DISTANCE (mm)	50 – 125	50 – 125	50 – 125	50 – 125	120 – 180
CONSUMPTION (Nm³/h)					
Heating oxygen flow by natural gas	27 – 33	27 – 33	27 – 33	36 – 52	84
Gas flow by natural gas	21 – 26	21 – 26	21 – 26	32 – 48	180 – 220
Heating oxygen flow by propan gas	27 – 33	27 – 33	27 – 33	36 – 52	84
Gas flow by propan gas	11	15	15	15	90 – 110
Cutting oxygen flow	58 – 93	71 – 114	86 – 135	211 – 378	280 – 400
PRESSURE CUTTING (bar)					
Heating oxygen pressure by natural gas	2 – 2.5	2 – 2.5	2 – 2.5	1.5 – 2.5	0.05
Gas pressure by natural gas	0.2 – 0.3	0.2 – 0.3	0.2 – 0.3	1 – 2	0.15 – 0.2
Heating oxygen pressure by propan gas	2 – 2.5	2 – 2.5	2 – 2.5	1.5 – 2.5	0.05
Gas pressure by propan gas	0.1	0.2	0.2	0.6	0.1 – 0.15
Cutting oxygen pressure	6 – 10	6 – 10	6 – 10	5 – 9	5 – 7
APPLICABLE CUTTING TORCHES					
SB 1200	+	+	+	+	
SB 2000					+
SPANNER WIDTH	SW 46	SW 46	SW 46	SW 46	SW 50

SD3 HSO NOZZLES

Optimised for manual operation. Allows for uneven movements or changes to the nozzle distance during the cutting process. The rugged construction also makes this nozzle ideal for scrap cutting applications.



CUTTING THICKNESS RANGE

mm	SD3 HSO
0	↓
100	
200	
300	
400	
500	
600	
700	
800	

MAIN CHARACTERISTICS

Spanner width range	SW 36
Gas pressure range	0.5 – 1.2 bar

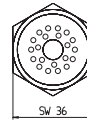

ITEM NO.	107884
CUTTING THICKNESS RANGE (mm)	50 – 500
CONSUMPTION (Nm³/h)	
Heating oxygen flow by natural gas	17 – 20
Gas flow by natural gas	15 – 18
Heating oxygen flow by propan gas	20 – 24
Gas flow by propan gas	10 – 14
Cutting oxygen flow	95
PRESSURE CUTTING (bar)	
Heating oxygen pressure by natural gas	1.8 – 2.2
Gas pressure by natural gas	0.8 – 1.2
Heating oxygen pressure by propan gas	2.0 – 2.5
Gas pressure by propan gas	0.5 – 0.8
Cutting oxygen pressure	8
APPLICABLE CUTTING TORCHES	
SHBA	+
SHBS	+
SPANNER WIDTH	SW 36

HFD 1F NOZZLES

Especially designed for the hand scarfing process. Well protected against abrasive movements with reinforced wearing ring, allowing for a long lifespan.

With its nozzle seat well anchored in the nozzle holder, the HFD 1F introduces an improved safety standard in the hand scarfing process.

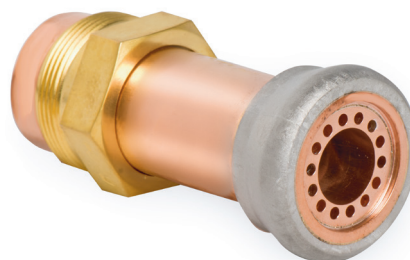

MAIN CHARACTERISTICS

Spanner width	SW 36
Scarfig oxygen pressure	10bar
Gas pressure range	0.3 – 0.5bar

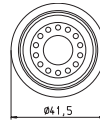

ITEM NO.

107648

CONSUMPTION (Nm³/h)

Heating oxygen flow by natural gas	19
Gas flow by natural gas	24
Scarfig oxygen flow	147

PRESSURE CUTTING (bar)

Heating oxygen pressure by natural gas	1.4 – 1.7
Gas pressure by natural gas	0.3 – 0.5
Scarfig oxygen pressure	10

APPLICABLE SCARFING TORCHES

MST 1500	+
MST 1200 CGA	+

SPANNER WIDTH

SW 36

MBR NOZZLES

Designed for the AMT Gega Scarfing Manipulator. The MBR 36 allows for a very fractional application, offering unrivalled operational efficiency. It was being specifically designed for very low gas consumption in scarfing processes.

Within its duty cycle, three separate assembly levels for scarfing are available. Switching between scarfing levels controls the scarfing range on the slab.



MAIN CHARACTERISTICS

Fractional scarfing possible

Very low gas consumption

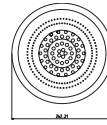

ITEM NO.

109912

CONSUMPTION (Nm³/h)

Heating oxygen flow by natural gas	190
Gas flow by natural gas	148
Scarfig oxygen flow step I	587
Scarfig oxygen flow step II	326
Scarfig oxygen flow step III	1235

PRESSURE SCARFING (bar)

Scarfig oxygen flow step I	4.5
Scarfig oxygen flow step II	0.4
Scarfig oxygen flow step III	1.1

APPLICABLE ITEMS

Manipulator

TORCHES

SB

SB 500 F

SB 800 F

SB 1200

SB 2000

HOBS 1S

SBK

SHBS / SHBA

SHBS-M(S) F / SHBA-M(S) F

Ignition Burner

SB TORCHES

The AMT Group SB torch range is a benchmark product in cutting technology. With the inner workings of the torch well shielded against the environment, long operating cycles are made possible. AMT Gega nozzle holders can be maintained on site and with little effort by use of a special seat re-cutting tool. Water cooling of the nozzle holder itself increases the lifespan of the cutting nozzle even further.

SB 500 F TORCHES

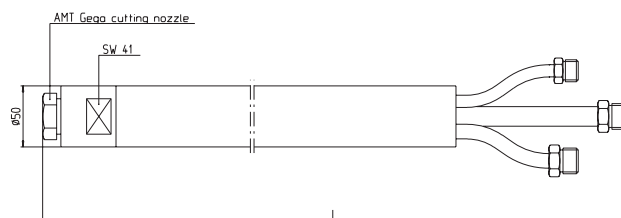
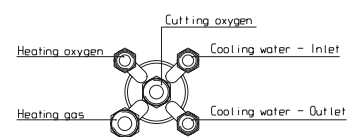

MAIN CHARACTERISTICS

Length range	500mm – 1900mm
Shaft pipe diameter	50mm

LENGTH (mm)	ITEM NO.	ITEM NO.
400	101512	
500	101513	
600	101514	
700	101515	
800	101516	
900	101517	
1000	101518	
1100	101519	
1200	101521	
1300	101523	111911
1400	101524	112072
1500	101525	112073
1600	109288	
1700	109337	
1800	101526	
1900	101527	

CONNECTIONS

Heating oxygen	G 3/8"	UNF 1 1/16 JIC
Cutting oxygen	G 1/2"	UNF 1 1/16 JIC
Heating gas	G 1/2"LH	UNF 7/8 JIC
Water inlet	G 3/8"	UNF 3/4 JIC
Water outlet	G 3/8"	UNF 3/4 JIC

APPLICABLE NOZZLES

SHEL F	+	+
SDS F	+(except 61 F)	+(except 61 F)
SDS FP	+	+
SDS FB	+	+

APPLICABLE GAUGE NOZZLES

	ITEM NO.	ITEM NO.
Heating gas	103507	112701
Cutting oxygen	103508	112831
Heating oxygen	103509	112702

SERVICE TOOLS (ITEM NO.)

Nozzle seat reamer	110411	110411
--------------------	--------	--------

SB 800 F TORCHES

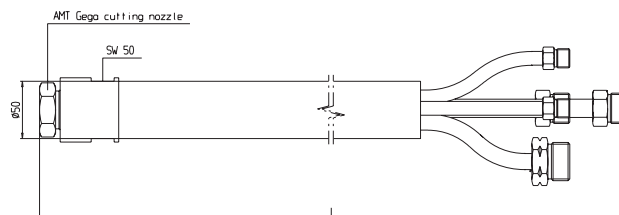
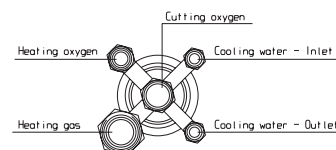

MAIN CHARACTERISTICS

Length range	1200 mm – 1700 mm
Shaft pipe diameter	50 mm

LENGTH (mm)	ITEM NO.
1200	112145
1700	113009

DIMENSIONS (mm)	
Shaft pipe diameter	50
Spanner width	SW 50

CONNECTIONS	
Heating oxygen	G 1/2"
Cutting oxygen	G 3/4"
Heating gas	G 1" LH
Water inlet	G 3/8"
Water outlet	G 3/8"

APPLICABLE NOZZLES	ITEM NO.
SDS 61 F	111951

SERVICE TOOLS	ITEM NO.
Nozzle seat reamer	112267

SB 1200 TORCHES

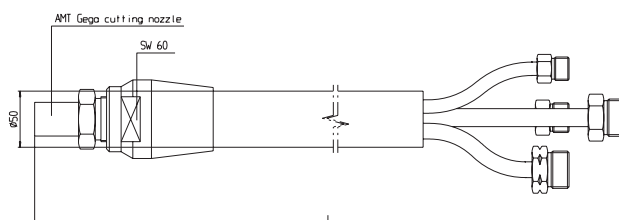
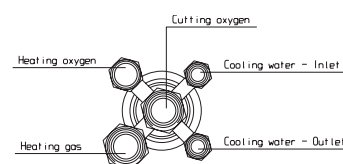

MAIN CHARACTERISTICS

Length range	500 mm – 1800 mm
Shaft pipe diameter	50 mm

LENGTH (mm)	ITEM NO.
500	112614
600	108903
700	101529
800	108904
900	108905
1000	108906
1100	101530
1200	108908
1300	108909
1400	108910
1500	108912
1600	108913
1700	108914
1800	108915

DIMENSIONS (mm)

Shaft pipe diameter	50
Spanner width	SW 60

CONNECTIONS

Heating oxygen	G 3/4"
Cutting oxygen	G 1"
Heating gas	G 1" LH
Water inlet	G 1/2"
Water outlet	G 1/2"

APPLICABLE NOZZLES

STD 1 – 4	+
-----------	---

APPLICABLE GAUGE NOZZLES

	ITEM NO.
Heating gas	103509
Cutting oxygen	112479
Heating oxygen	103507

SERVICE TOOLS

	ITEM NO.
Nozzle seat reamer	111379

SB 2000 TORCHES

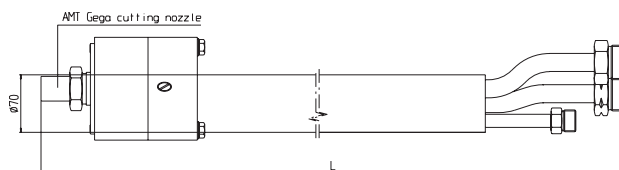
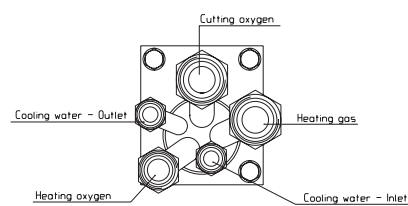

MAIN CHARACTERISTICS

Length

1200 mm

LENGTH (mm)	ITEM NO.
1200	114180

DIMENSIONS (mm)	
Shaft pipe diameter	70

CONNECTIONS	
Heating oxygen	G 1"
Cutting oxygen	G 1 1/4"
Heating gas	G 1 1/4" LH
Water inlet	G 3/4"
Water outlet	G 3/4"

APPLICABLE NOZZLES	ITEM NO.
STD 5	114181

HOBS 1S TORCHES

The AMT Gega HOBS 1S torch is the technological counterpart to the AMT Gega HOT nozzle range. The fastest separation system in autogenous technology, this sophisticated cutting system is based on a high pressure procedure. The HOBS 1S unit is designed for operation in the area of smelting works and impresses with a high level of robustness in daily steel works operation.



MAIN CHARACTERISTICS

Length range	500mm – 1500mm
Shaft pipe diameter	50mm

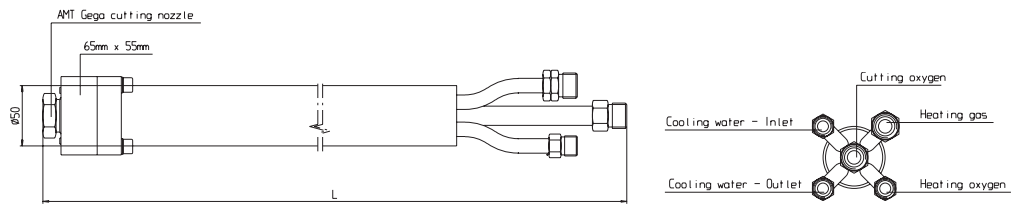

LENGTH (mm)	ITEM NO.
500	106892
600	106893
700	106894
800	106895
900	106896
1000	106897
1100	106898
1200	106899
1300	106900
1400	106902
1500	106903

DIMENSIONS (mm)	
Shaft pipe diameter	50

CONNECTIONS	
Heating oxygen	G 3/8"
Cutting oxygen	G 1/2"
Heating gas	G 1/2"LH
Water inlet	G 3/8"
Water outlet	G 3/8"

APPLICABLE NOZZLES	ITEM NO.
HOT 1 S	+

SBK TORCHES

SBK type torches are specifically designed for the mobile cutting system Corti. It shares its origin with the SB 500 F, however lacking the cooling jacket. The advantage of the SBK compared to the SB 500 F is a lighter design due to the missing parts of the cooling items and the cooling water itself. The same nozzles as in the SB 500 F can be used.



MAIN CHARACTERISTICS

Length range	400mm – 1000mm
Shaft pipe diameter	32mm

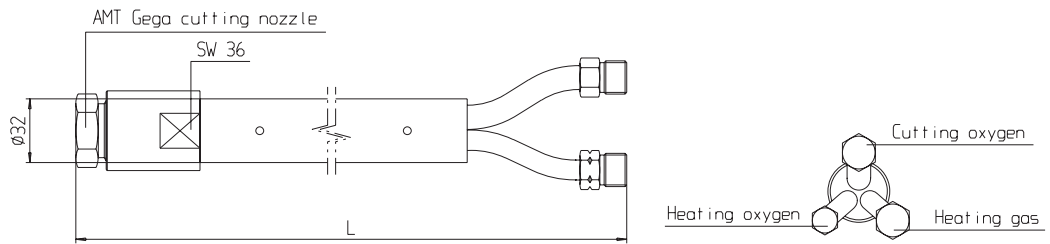

LENGTH (mm)	ITEM NO.
400	101528
500	112008
600	112010
700	109869
900	109871
1000	113273

DIMENSIONS (mm)	
Shaft pipe diameter	32
Spanner width	SW 36

CONNECTIONS	
Heating oxygen	G 1/4"
Cutting oxygen	G 3/8"
Heating gas	G 3/8"LH

APPLICABLE NOZZLES	
SHEL F	+
SDS F	+(except 61 F)
SDS FP	+
SDS FB	+

SERVICE TOOLS	ITEM NO.
Nozzle seat reamer	110411

SHBS / SHBA TORCHES

The manual cutting torches by AMT Gega are called SHBS or SHBA and differ in the angle of the nozzle holder. With the model S, the nozzle seat is straight on the torch axis, whereas the A variant shows a 90° cranking at the head.

The area of use of this product is the emergency separation of slabs – strand situations and in manual cutting processes, and also heavy scrap cutting. A powder machine can be provided on request.



SHBS



SHBA

SHBS

SHBA

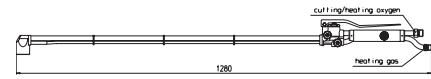
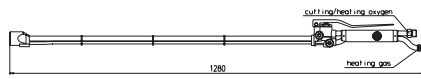

ITEM NO.	108983	108972
DIMENSIONS (mm)		
Length	1280	1280
Spanner width	SW 27	SW 27
CONNECTIONS		
Cutting oxygen	G 1/2"	G 1/2"
APPLICABLE NOZZLES		
	ITEM NO.	ITEM NO.
SD 3 HSO	107884	107884
SERVICE TOOLS		
	ITEM NO.	ITEM NO.
Nozzle seat reamer	103304	103304

SHBS-M(S) F / SHBA-M(S) F TORCHES

For your personal safety in the smelting works process, AMT Gega provides emergency cutting torches. This development impresses with a high level of robustness and reliability in emergency situations.

As with many AMT Gega products, a large amount of additional equipment is available. This type of torch can be manufactured from 1200 to 5000 mm.



SHBS-M(S) F

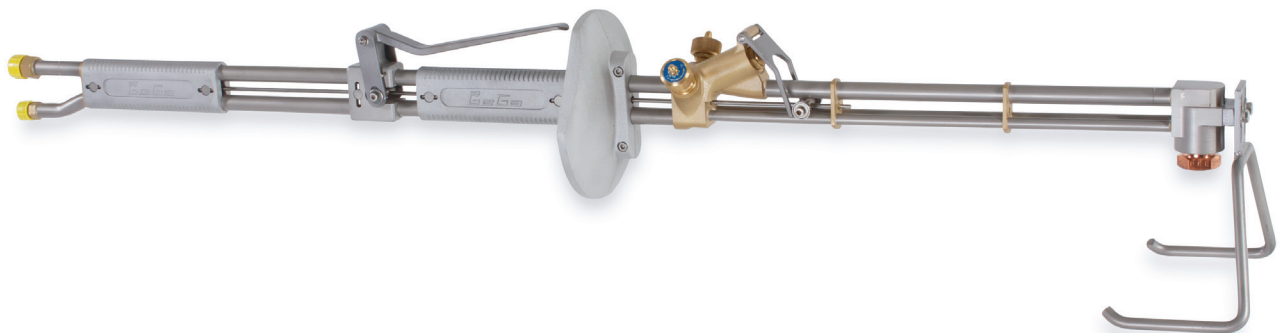

SHBA-M(S) F

MAIN CHARACTERISTICS

Length range	1200 mm – 5000 mm
Spanner width	SW 27

SHBS-M F

SHBS-MS F

SHBA-M F

SHBA-MS F

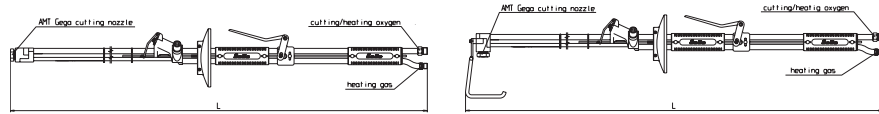

LENGTH (mm)	ITEM NO.	ITEM NO.	ITEM NO.	ITEM NO.
1200	107413		107393	
1500	107414		107394	
1800	107415		107395	
2000	112022			
2100	107416		107396	
2400	107417		107397	
2700	107418		107404	
3000	107419		107405	
3500		107420		109354
4000		109418		107407
5000		113142		

DIMENSIONS

Spanner width	SW 27	SW 27	SW 27	SW 27
---------------	-------	-------	-------	-------

CONNECTIONS

Cutting oxygen	G 1/2"	G 1/2"	G 1/2"	G 1/2"
Heating gas	G 3/8"LH	G 3/8"LH	G 3/8"LH	G 3/8"LH

APPLICABLE NOZZLES

SHEL F	+	+	+	+
SDS F (excludes SDS 61 F)	+	+	+	+
SDS FP	+	+	+	+
SDS FB	+	+	+	+

SERVICE TOOLS

SERVICE TOOLS	ITEM NO.	ITEM NO.	ITEM NO.	ITEM NO.
Nozzle seat reamer	110411	110411	110411	110411

IGNITION BURNERS TORCHES

This new design of the ignition burner is directly installed on the burner and enables exceptionally safe operation.

This type of ignition burner can be ignited in any position. The fix position delivers significantly improved ignition reliability.



MAIN CHARACTERISTICS

Length range	300mm – 1400mm
Shaft pipe diameter	21.3mm

IGNITION BURNER

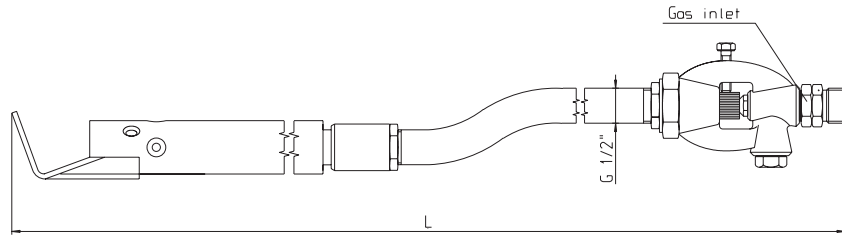

LENGTH (mm)	ITEM NO.
300	109873
400	109874
500	108929
600	108928
700	108927
800	108926
900	108925
1000	108924
1100	108923
1200	108922
1300	108921
1400	107666

DIMENSIONS (mm)	
Shaft pipe diameter	21.3

CONNECTIONS	
Inlet gas	G 1/2" LH M

PRESSURE (mbar)	
Propan gas	60 – 80
Natural gas	80 – 120

FINE ADJUSTMENT VALVE TYPE 920 VALVES

The AMT Gega fine adjustment valve is responsible for the exact media dosage of the heating system. The process path provides short routes from the valve to the consumer. For this reason, this component is positioned as close as possible to the torch, without being exposed to heat radiation.

Due to uneven lengths of supply pipelines and hoses, the introduction of a fine adjustment valve is required. This is compensated by using an AMT Gega fine adjustment valve.



MAIN CHARACTERISTICS

Adjustable	yes
Regulation	manual
Max. pressure	50bar

TYPE	920/400	920/413	920/431	920/433
MEDIUM	Oxygen, CPM	Oxygen, CPM	Oxygen, CPM	Oxygen, CPM
ITEM NO.	106785	102757	106717	106718
DIMENSIONS (mm)				
Height	60	60	60	60
Width	25	25	25	25
Length	48	92.5	92.5	98
CONNECTION				
Inlet 1	G 1/4" F	G 1/4" M	G 1/4" F	G 1/4" F
Outlet 1	G 1/4" F	G 1/4" F	G 1/4" M	G 1/4" F
MATERIAL	Brass	Brass	Brass	Brass

VALVES

Fine adjustment valve / Type 920

Gas flow controller / Type 880

2/2 way valve / Type 955

2/2 way valve / Type 966

GAS FLOW CONTROLLER TYPE 880 VALVES

The AMT Gega fine adjustment valve is responsible for the exact media dosage of the heating system. The process path provides short routes from the valve to the consumer. For this reason, this component is positioned as close as possible to the torch, without being exposed to heat radiation.

Due to uneven lengths of supply pipelines and hoses, the introduction of a fine adjustment valve is required. This is compensated by using an AMT Gega fine adjustment valve.



MAIN CHARACTERISTICS

Adjustable	yes
Electrical detachable	yes
Max. pressure	25bar

GAS FLOW CONTROLLER	880 / A	880 / B	880 / C	880 / D	880 / E
MEDIUM	Oxygen	Oxygen	Oxygen	Oxygen	Oxygen
ITEM NO.	112740	112741	112742	114189	112854
DIMENSIONS (mm)					
Height	173.5	173.5	173.5	173.5	173.5
Width	114	130	130	196	196
Length	143	143	143	143	147
CONNECTION					
Inlet 1	G 3/8" M	G 3/8" M	G 3/8" M	G 3/8" M	G 1/2" M
Outlet 1	G 3/8" M	G 3/8" M	G 3/8" M	G 3/8" M	G 1/2" M
COIL VOLTAGE					
AC	24V / 50Hz – 240V / 50Hz	24V / 50Hz – 240V / 50Hz	24V / 50Hz – 240V / 50Hz	24V / 50Hz – 240V / 50Hz	24V / 50Hz – 240V / 50Hz
DC	12V – 220V	12V – 220V	12V – 220V	12V – 220V	12V – 220V
BYPASS	No	Yes	Yes	Yes	Yes
BYPASS ELECTRICAL DETACHABLE	No	No	Yes	No	Yes
MATERIAL	Brass	Brass	Brass	Brass	Brass
SERVICE KIT (ITEM NO.)	102534	102534	102534	102534	102534
CONNECTION TO IGNITION TORCH	No	No	No	Yes	Yes

GAS FLOW CONTROLLER	880 / A	880 / B	880 / C	880 / D	880 / E
MEDIUM	CPM	CPM	CPM	CPM	CPM
ITEM NO.	112743	112744	112745	112746	112853
DIMENSIONS (mm)					
Height	173.5	173.5	173.5	173.5	173.5
Width	114	130	130	196	196
Length	143	143	143	143	147
CONNECTION					
Inlet 1	G 1/2" LH M	G 1/2" LH M	G 1/2" LH M	G 1/2" LH M	G 1/2" LH M
Outlet 1	G 1/2" LH M	G 1/2" LH M	G 1/2" LH M	G 1/2" LH M	G 1/2" LH M
COIL VOLTAGE					
AC	24V / 50Hz – 240V / 50Hz	24V / 50Hz – 240V / 50Hz	24V / 50Hz – 240V / 50Hz	24V / 50Hz – 240V / 50Hz	24V / 50Hz – 240V / 50Hz
DC	12V – 220V	12V – 220V	12V – 220V	12V – 220V	12V – 220V
BYPASS	No	Yes	Yes	Yes	Yes
BYPASS ELECTRICAL DETACHABLE	No	No	Yes	No	Yes
MATERIAL	Brass	Brass	Brass	Brass	Brass
SERVICE KIT (ITEM NO.)	102534	102534	102534	102534	102534
CONNECTION TO IGNITION TORCH	No	No	No	Yes	Yes

GAS FLOW CONTROLLER	880 / A	880 / B	880 / C	880 / D	880 / E
MEDIUM	Oxygen, CPM	Oxygen, CPM	Oxygen, CPM	Oxygen, CPM	Oxygen, CPM
ITEM NO.	102531	102529	112600	110769	110770
DIMENSIONS (mm)					
Height	173.5	173.5	173.5	173.5	173.5
Width	114	130	130	196	196
Length	143	143	143	143	147
CONNECTION					
Inlet 1	G 1/2" F	G 1/2" F	G 1/2" F	G 1/2" F	G 1/2" F
Outlet 1	G 1/2" F	G 1/2" F	G 1/2" F	G 1/2" F	G 1/2" F
COIL VOLTAGE					
AC	24V / 50Hz – 240V / 50Hz	24V / 50Hz – 240V / 50Hz	24V / 50Hz – 240V / 50Hz	24V / 50Hz – 240V / 50Hz	24V / 50Hz – 240V / 50Hz
DC	12V – 220V	12V – 220V	12V – 220V	12V – 220V	12V – 220V
BYPASS	No	Yes	Yes	Yes	Yes
BYPASS ELECTRICAL DETACHABLE	No	No	Yes	No	Yes
MATERIAL	Brass	Brass	Brass	Brass	Brass
SERVICE KIT (ITEM NO.)	102534	102534	102534	102534	102534
CONNECTION TO IGNITION TORCH	No	No	No	Yes	Yes

2/2 WAY VALVE TYPE 955 VALVES

The 2/2 way valve manufactured by AMT Gega closes and opens the cutting oxygen flow of the nozzle. The capacity of the closer is up to 40 bar. This component is designed to be very robust and long lasting, even a dusty environment does not impede the function of this 2/2 way valve in any way.



MAIN CHARACTERISTICS

Electrical detachable	yes
Max. pressure	40bar

TYPE

955

MEDIUM

Oxygen, CPM

ITEM NO.

112828

DIMENSIONS (mm)

Height

112

Width

60

Length

147

CONNECTION

Inlet 1

G 1/2" M

Outlet 1

G 1/2" M

COIL VOLTAGE

AC

24V / 50Hz – 240V / 50Hz

DC

12V – 220V

MATERIAL

Brass

SERVICE KIT (ITEM NO.)

112655

2/2 WAY VALVE TYPE 966 VALVES

The 2/2 way valve manufactured by AMT Gega closes and opens the cutting oxygen flow of the nozzle. The capacity of the closer is up to 25 bar. This component is designed to be very robust and long lasting, even a dusty environment does not impede the function of this 2/2 way valve in any way.



MAIN CHARACTERISTICS

Electrical detachable	yes
Max. pressure	25bar

TYPE

966

MEDIUM

Oxygen, CPM

ITEM NO.

112827

DIMENSIONS (mm)

Height

89

Width

38

Length

127

CONNECTION

Inlet 1

G 1/2" M

Outlet 1

G 1/2" M

COIL VOLTAGE

AC

24V / 50Hz – 240V / 50Hz

DC

12V – 220V

MATERIAL

Brass

REGULATORS

GS range
GL range
Kuppel valves
GK regulators

GS RANGE REGULATORS

The GS range is the introductory model of the AMT Gega regulator range. Due to the simple construction of this range, AMT Gega has succeeded in offering very robust and user-friendly regulators. The spring loaded diaphragm regulators were specially conceived for manual and portable cutting applications, like every G regulator in the AMT family, and offer good visual control of the flow medium.



MAIN CHARACTERISTICS

Regulate	manual
Max. pressure	40bar
Pressure range	0.5 – 25bar

GL RANGE REGULATORS

The AMT Gega GL range is a high-end regulator range and offers many advantages, which no other product in the market place can provide.

The unit combines a spring loaded pressure regulator with a manual shut off valve, filter, pilot needle valve, and solenoid control valve, all in one compact item. This makes connecting many separate components with pipe fittings redundant, thus reducing the overall cost of the installation and removing the potential for hazardous leaks. Get in touch to explore many equipment variants or to discuss your individual needs for customization.

Amongst other application, this diaphragm regulating unit is used in AMT Gega torch cutting machines, ensuring the torch pressure remains correct and stable, or, when combined with PLC control, automating the switching of the flame between its various modes.



MAIN CHARACTERISTICS

Regulate	manual
Max. pressure	40bar
Pressure range	0.5 – 25bar

GL RANGE	GL 1S					GL 2S					GL 3S		GL 4S				
	GL 1S	GL 1S / M	GL 1S / MS	GL 1S / MCG	GL 1S / MSG	GL 2S	GL 2S / M	GL 2S / MS	GL 2S / MCG	GL 2S / MSG	GL 3S	GL 3S / M	GL 4S	GL 4S / M	GL 4S / MS	GL 4S / MCG	GL 4S / MSG
CONNECTION																	
Inlet 1	G 3/4" LHM					G 3/4" M					G 3/4" M		G 3/4" F				
Outlet 1	G 3/4" LHM					G 3/4" M					G 3/4" M		G 3/4" F				
Outlet 2	-					-					-		-				
BYPASS																	
Main-solenoid valve	-	1	1	1	1	-	1	1	1	1	-	1	-	1	1	1	1
Bypass-solenoid valve with manometer-connection	-	-	-	-	1	-	-	-	-	1	-	-	-	-	-	-	1
Bypass-solenoid valve without manometer-connection	-	-	1	-	-	-	-	1	-	-	-	-	-	-	1	-	-
Bypass-regulator valve with manometer-connection	-	-	-	1	-	-	-	-	1	-	-	-	-	-	-	1	-
REGULATE	Manual					Manual					Manual		Manual				
MEDIUM	CPM					Oxygen					Oxygen		Acetylene				
MATERIAL	Main body: Brass / Wetted parts: Brass & stainless steel / Diaphragms & seals: Nitrile																
SERVICE KIT (ITEM NO.)	1x102542	1x102542, 1x107185	1x102542, 1x107185, 1x102538	1x102542, 1x107185, 1x102538	1x102542, 1x107185, 1x102538	1x102543	1x102542, 1x107185	1x102542, 1x107185, 1x102538	1x102542, 1x107185, 1x102538	1x102542, 1x107185, 1x102538	1x102544	1x102542, 1x107185	1x102545	1x102542, 1x107185	1x102542, 1x107185, 1x102538	1x102542, 1x107185, 1x102538	1x102542, 1x107185, 1x102538
SEALING KIT (ITEM NO.)	1x102511, 1x107185	1x102511, 1x107185	1x102511, 1x107185, 1x102538	1x102511, 1x107185, 1x102538	1x102511, 1x107185, 1x102538	1x102511	1x102511, 1x107185	1x102511, 1x107185, 1x102538	1x102511, 1x107185, 1x102538	1x102511, 1x107185, 1x102538	1x102511	1x102511, 1x107185	1x102511	1x102511, 1x107185	1x102511, 1x107185, 1x102538	1x102511, 1x107185, 1x102538	1x102511, 1x107185, 1x102538

GL RANGE	GL 1D	GL 2D	GL 3D	GL 4D
	GL 1D / MCG GL 1D / MSG	GL 2D / MCG GL 2D / MSG	GL 3D / M	GL 4D / MCG GL 4D / MSG
CONNECTION				
Inlet 1	G 3/4" LH M	G 3/4" M	G 3/4" M	G 3/4" F
Outlet 1	G 1/2" LH M	G 3/8" M	G 1/2" M	G 1/2" F
Outlet 2	G 1/2" LH M	G 3/8" M	G 1/2" M	G 1/2" F
BYPASS				
Main-solenoid valve	2 2	2 2	1	2 2
Bypass-solenoid valve with manometer-connection	- 2	- 2	-	- 2
Bypass-solenoid valve without manometer-connection	- -	- -	-	- -
Bypass-regulator valve with manometer-connection	2 -	2 -	-	2 -
REGULATE				
	Manual	Manual	Manual	Manual
MEDIUM				
	CPM	Oxygen	Oxygen	Acetylene
MATERIAL Main body: Brass / Wetted parts: Brass & stainless steel / Diaphragms & seals: Nitrile				
SERVICE KIT				
	1x102542, 1x102543, 2x102538 1x102542, 1x102543, 2x102538	1x102542, 1x102543, 2x102538 1x102542, 1x102543, 2x102538	2x102544	1x102542, 1x102543, 2x102538 1x102542, 1x102543, 2x102538
SEALING KIT				
	1x111099, 2x102538 1x111099, 2x102538	1x111099, 2x102538 1x111099, 2x102538	2x102513	1x111099, 2x102538 1x111099, 2x102538

KUPPEL VALVES REGULATORS

The dome-loaded pressure regulators in the AMT product portfolio are labelled with a “K”.

A regulating unit is required to prevent occasional pressure variations in the medium network from reaching the torches. Combine with AMT Gega flow controllers or AMT Gega fine adjustment valves to achieve ideal torch settings. Many equipment options are available to comply with specific customer requirements.

The advantages of this regulator are in the compact construction. In addition, the unit can be controlled electrically from the console, depending on the selected equipment variant, making the manual adjustment of pressure settings in a danger zone obsolete. A further performance characteristic is the comparably high medium throughput.



K 20



KB 42

MAIN CHARACTERISTICS

Product	KB-S
Max. pressure K 20	40bar
Max. pressure KB(S) 42	50bar

TYPE	K 20	KB(S) 42	KB(S) 42	KB(S) 42
CONNECTION				
Inlet 1	G 3/4" M	M64X 4 F	Flange DN50/ 60.3 PN40	G 1 1/4" LH M
Outlet 1	G 3/4" M	M64X 4 F	Flange DN50/ 60.3 PN40	G 1 1/4" LH M
REGULATE				
KB / A	electrical	electrical	electrical	electrical
KB / B	electrical	electrical	electrical	electrical
KB / C	manual	manual	manual	manual
CONTROL				
KB / A	internal	internal	internal	internal
KB / B	external	external	external	external
KB / C	external	external	external	external
MEDIUM	CPM, Oxygen	CPM, Oxygen	CPM, Oxygen	CPM, Oxygen
MATERIAL	Brass	Brass or stainless steel	Brass or stainless steel	Brass or stainless steel
SEALING KIT (ITEM NO.)	102686	106503	106503	106503

GK REGULATORS

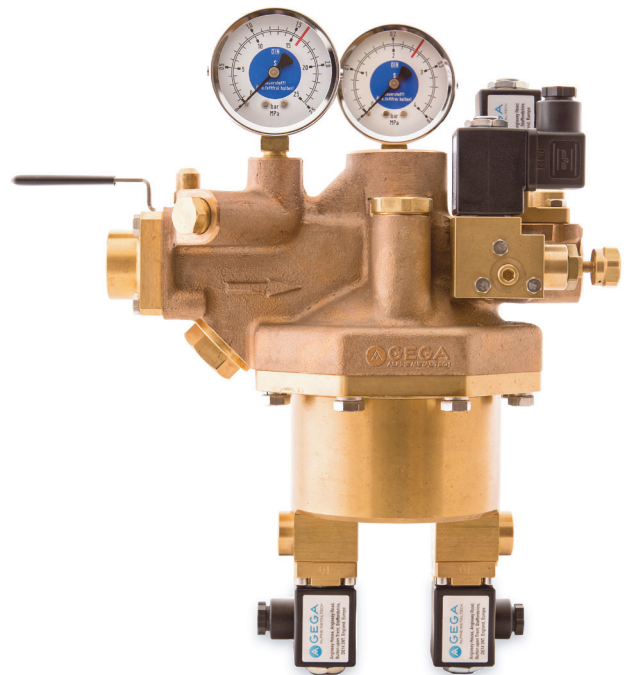

MAIN CHARACTERISTICS

Operating media	Heating gas, oxygen
Application	Regulation of prepressure for required system pressure
Main parts	Solid die casting housing. inlet-ballvalve. dirt trap. lockable pressure gauges. adjusting toggle for pressure adjusting
Optional	Main Solenoid valve. Bypass valve for the integrated pilot flame (with Solenoid valve if required)
Pressure	Maximal inlet pressure 40 bar Maximal outlet pressure 37.7 bar Operating pressure 0.5 to 18 bar
Weight	10 to 12 kg depending on version
Product variations	All GK series contain two versions:
	- Single outlet - Double outlet (for using 2 torches)
Type S	Bypass with Solenoid valve (w/o Manometerconnector)
Type CG	Bypass with manometerconnector (w/o solenoid valve)
Type SG	Bypass with solenoid valve and manometerconnector
Item no.:	Available on request

SCARFER

Machine scarfer

MHD 300

HD SW 27/10

MH 310

MBR 36

Hand scarfer

MST 1500 / CGA

SHF-100 F 1500

MACHINE SCARFER SCARFER

The ranges MH and MHD are large-scale scarfing burners of the AMT group. The sophisticated technology inside enables a high finish quality for the scarfing process.

With the help of the machine scarfer, finish errors such as heat cracks or shrinkage cavities are eliminated. Due to the high AMT Gega standard with regards to choice of materials and manufacturing precision, a stable process is achieved in the surface removal, with long service lives.

For better interchangeability of components with a high thermal load, the entire unit has a modular structure. Various widths of scarfers are available, so that an individually customised solution can be offered.

Available on request.

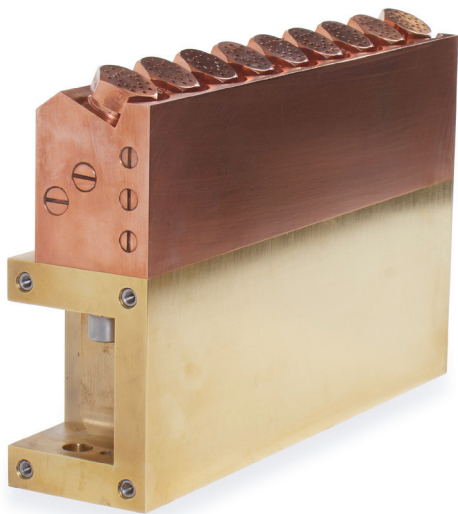

MHD 300

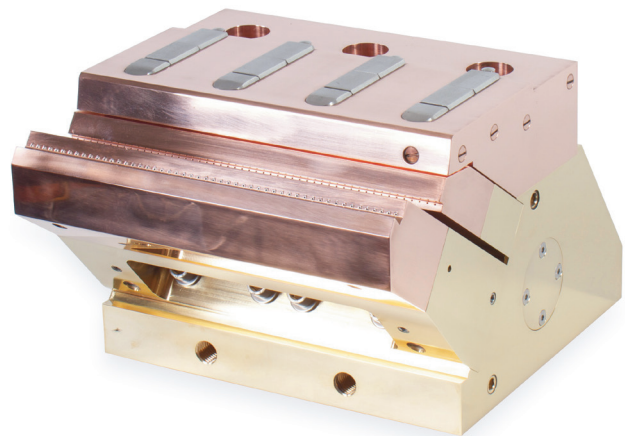

MH 310

HAND SCARFER SCARFER

Hand scarfers from AMT Gega bear the designation MST and SHF. The latest version of the hand scarfer, the MST variant, impresses with its light construction and thusly improved ergonomics. By integrating the scarf oxygen valve into the heating medium regulator, improved handling is achieved. The SHF is a heavy design and distinguishes itself with various safety applications. A shield is installed, which protects the user from hazardous flame.

Combined with the flaming nozzle HFD 1F, this equipment makes an impressive manual component, scarfing efficiently at a high level. Experience a particularly wide scarfing track with very good ergonomics in this particular setup.

All AMT Gega hand scarfing torches are fitted with an automatic ignition wire feed rate, enhancing the ignition behaviour of the scarfer significantly.

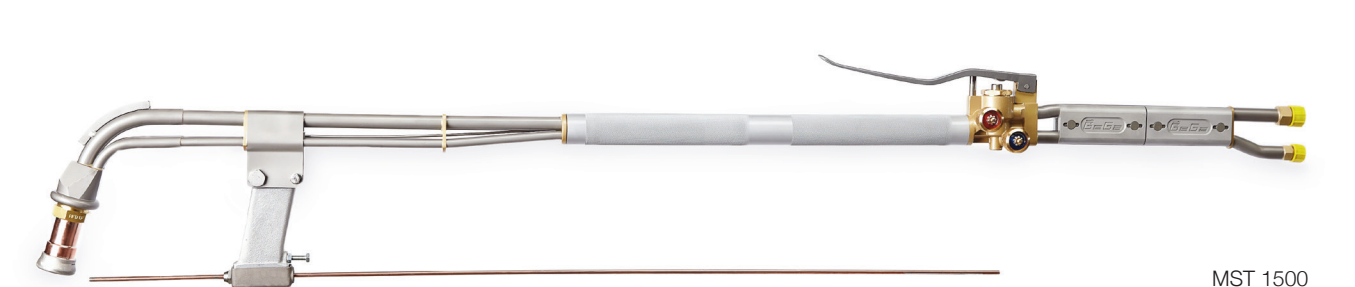
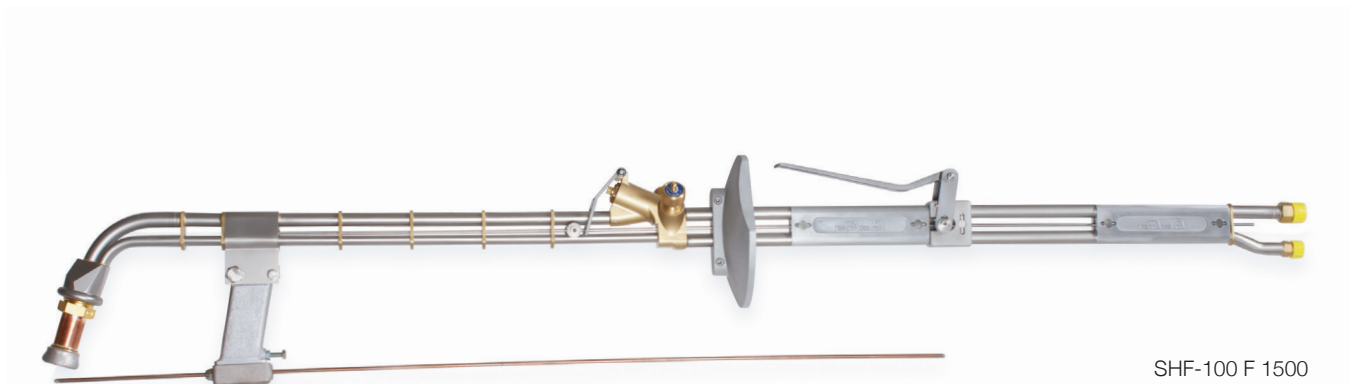

SHF-100 F 1500

MST 1500

MST 1200 CGA

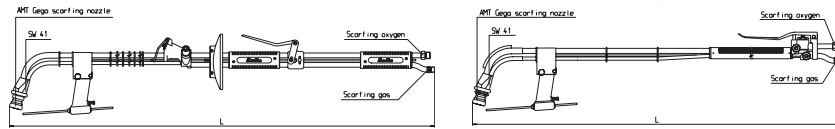

LENGTH (mm)	109448	111581	111815
DIMENSIONS (mm)			
Length	1500	1500	1200
Spanner width	41	41	41
CONNECTIONS			
Scarfing oxygen	G 1/2"	G 1/2"	7/8" UNF/ CGA
Heating gas	G 3/8"LH	G 3/8"LH	9/16" UNF/ CGA
APPLICABLE NOZZLES (ITEM NO.)			
HFD 1 F	107648	107648	107648

SAFETY EQUIPMENT

Safety devices

LG/GRM

LG/GRM D / LG/GRM D R1.0

SIMAX 5 / SIMAX 8

SIMAX LG VII

SIMAX 4NH

DEMAX 5

Non-return devices

LG/GRM

LG/GRM/S

GRV2-20

SAFETY DEVICES

SAFETY EQUIPMENT

All AMT Gega burners are provided with safety elements to ensure safe, frictionless operation. When dealing with explosive gas and oxygen mixtures, safety devices must be used to avoid flashbacks. They exhibit exceptional, “Made in Germany” build quality and fulfil the required DIN EN 746-2 standards.

These safety devices are specially optimised for autogenous use, offering maximum protection for machine components.

LG/GRM SAFETY DEVICES



	GRM	GRM	GRM	GRM	GRM	GRM
ITEM NO.	107805	106548	106986	107360	106857	107800
MAX. PRESSURE (bar)	25	25	25	25	25	25
MEDIUM	Oxygen	Oxygen	Oxygen	Oxygen	Oxygen	Oxygen
CONNECTION						
Inlet 1	G 1/4" M	G 3/8" M	G 1/2" M	UNF 7/8" CGA M	UNF 1 1/16" JIC M	W 24-14 M
Outlet 1	G 1/4" F	G 3/8" F	G 1/2" F	UNF 7/8" CGA F	UNF 1 1/16" JIC F	W 24-14 F
DIMENSIONS (mm)						
Height	118	119	125	134	142	135
Width	32	32	32	32	32	32
Length	32	32	32	32	32	32
APPLICABLE TORCHES						
SBK 500 F	+					
SB 500 F		+			+	+
SB 800 F			+			
HOBS 1S		+				

LG/GRM D SAFETY DEVICES



	GRM D	GRM D	GRM D	GRM D	GRM D	GRM D	GRM D
ITEM NO.	107807	107798	107803	107809	111773	107808	107799
MAX. PRESSURE (bar)	5	5	5	5	5	5	5
MEDIUM	CPM	CPM	CPM	CPM	CPM	CPM	CPM
CONNECTION							
Inlet 1	G 3/8" LH M	G 3/4" LH M	G 1/2" LH M	UNF 7/8" JIC M	UNF 1 1/16" JIC M	UNF 7/8" LH CGA M	W 28-18 LH M
Outlet 1	G 3/8" LH F	G 3/4" LH F	G 1/2" LH F	UNF 7/8" JIC F	UNF 1 1/16" JIC F	UNF 7/8" LH CGA F	W28-18 LH F
DIMENSIONS (mm)							
Height	165	177	171	186	185	181	135
Width	32	32	32	32	32	32	32
Length	32	32	32	32	32	32	32
APPLICABLE TORCHES							
SBK 500 F	+						
SB 500 F			+	+			+
HOBS 1S			+				

LG/GRM D R1.0 SAFETY DEVICES



	GRM D R1.0	GRM D R1.0	GRM D R1.0
ITEM NO.	110393	107966	112025
MAX. PRESSURE (bar)	10	10	10
MEDIUM	CPM	CPM	CPM
CONNECTION			
Inlet 1	G 3/8" LH M	G 1/2" LH M	UNF 9/16" LH CGA M
Outlet 1	G 3/8" LH F	G 1/2" LH F	UNF 9/16" LH CGA F
DIMENSIONS (mm)			
Height	165	171	162
Width	32	32	32
Length	32	32	32
APPLICABLE TORCHES			
SBK 500 F	+		
SB 500 F		+	
HOBS 1S		+	

SIMAX 5 / SIMAX 8 SAFETY DEVICES



	SIMAX 5	SIMAX 5	SIMAX 5	SIMAX 8	SIMAX 8
ITEM NO.	106622	106847	110785	106655	106654
MAX. PRESSURE (bar)	5	15	5	15	5
MEDIUM	CPM	Oxygen	Coke oven gas	Oxygen	CPM
CONNECTION					
Inlet 1	G 1" F	G 1" F	G 1" F	G 1" F	G 1" F
Outlet 1	G 1" F	G 1" F	G 1" F	G 1" F	G 1" F
DIMENSIONS (mm)					
Height	160	160	163	172	172
Width	89	89	89	117	117
Length	89	89	89	117	117

SIMAX LG VII SAFETY DEVICES



	SIMAX LG	SIMAX LG	SIMAX LG	SIMAX LG
ITEM NO.	113137	113136	106623	106629
MAX. PRESSURE (bar)	25	2.5	25	2.5
MEDIUM	Oxygen	CPM	Oxygen	Oxygen
CONNECTION				
Inlet 1	G 3/4" M	G 1" LH M	G 1 1/4" F	G 1 1/4" F
Outlet 1	G 3/4" M	G 1" LH M	G 1 1/4" F	G 1 1/4" F
DIMENSIONS (mm)				
Height	175	175	146	146
Width	75	75	75	75
Length	75	75	75	75
APPLICABLE TORCHES				
SB 800 F				+
SB 1200	+	+		

SIMAX 4NH SAFETY DEVICES



SIMAX 4NH

ITEM NO.	109300
----------	--------

MAX. PRESSURE	12
---------------	----

MEDIUM	CPM
--------	-----

CONNECTION

Inlet 1	G 1" F
Outlet 1	G 1" F

DIMENSIONS (mm)

Height	146
Width	75
Length	75

APPLICABLE ITEM

Gas control unit	+
------------------	---

DEMAX 5 SAFETY DEVICES

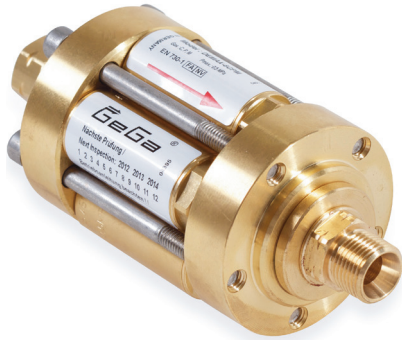

	DEMAX 5	DEMAX 5	DEMAX 5	DEMAX 5	DEMAX 5	DEMAX 5
ITEM NO.	106626	106627	107788	107789	113351	113352
MAX. PRESSURE	5	25	25	5	25	5
MEDIUM	CPM	Oxygen	Oxygen	CPM	Oxygen	CPM
CONNECTION						
Inlet 1	G 3/8" LH F	G 1/2" F	G 1" F	G 1" F	G 3/4" M	G 3/4" M
Outlet 1	G 3/8" LH M	G 1/2" M	G 1" F	G 1" F	G 3/4" F	G 3/4" F
DIMENSIONS (mm)						
Height	142	150	111	111	n/a	n/a
Width	60	60	65	65	n/a	n/a
Length	60	60	65	65	n/a	n/a
APPLICABLE ITEM						
Gas control unit	+	+	+	+	+	+

NON-RETURN DEVICES **SAFETY EQUIPMENT**

For large oxygen mass flows, AMT Gega offers simple non-return valves. These contain a standard flap controller to reduce losses. Therefore, machine pressures similar to the inlet pressures can be realised.

LG/GRM/S NON-RETURN DEVICES



	GRM/S	GRM/S	GRM/S	GRM/S	GRM/S	GRM/S	GRM/S
ITEM NO.	106552	106549	113159	108398	108246	106846	107496
MAX. PRESSURE	25	25	25	25	25	25	25
MEDIUM	Oxygen	Oxygen	Oxygen	Oxygen	Oxygen	Oxygen	Oxygen
CONNECTION							
Inlet 1	G 3/8" M	G 1/2" M	G 3/4" M	W 28-18 JIS M	UNF 7/8" CGA M	UNF 1 1/16" JIC M	UNF 1 1/4" CGA M
Outlet 1	G 3/8" F	G 1/2" F	G 3/4" F	W 28-18 JIS F	UNF 7/8" CGA F	UNF 1 1/16" JIC F	UNF 1 1/4" CGA F
DIMENSIONS (mm)							
Height	119	125	n/a	135	134	142	139
Width	32	32	32	32	32	32	32
Length	32	32	32	32	32	32	32
APPLICABLE TORCHES							
SBK 500 F	+						
SB 500 F		+		+	+	+	
SB 800 F			+				
HOBS 1S		+					

GRV2-20 NON-RETURN DEVICES



	GRV2-20	GRV2-20	GRV2-20	GRV2-20	GRV2-20	GRV2-20	GRV2-25
ITEM NO.	107581	107580	109166	109168	109167	109169	111132
MAX. PRESSURE	10	10	10	10	10	10	10
MEDIUM	Oxygen	CPM	Oxygen	CPM	Oxygen	CPM	CPM
CONNECTION							
Inlet 1	G 3/4"	G 3/4"	G 1"	G 1"	G 1 1/4"	G 1 1/4"	G 1"
Outlet 1	G 3/4"	G 3/4"	G 1"	G 1"	G 1 1/4"	G 1 1/4"	G 1"
DIMENSIONS (mm)							
Height	126	126	126	126	126	126	127
Width	65	65	65	65	65	65	65
Length	65	65	65	65	65	65	65

HOSES

2SS
2SG
2TE
3TE
PTFE

HOSES

Due to the special requirements in the smelting works process, all installed components must pass high requirements. This also applies to hose connections. Apart from high temperature resistance of the materials used, the hoses are also subject to a BAM test. Various coating materials adjust the hose connection to the relevant temperature interval.

After press fitting the connections used in AMT Gega machines, they are vigorously tested for tightness and pressure resistance in an individual cycle. If required, AMT Gega will certify these test cycles.

2SS HOSES

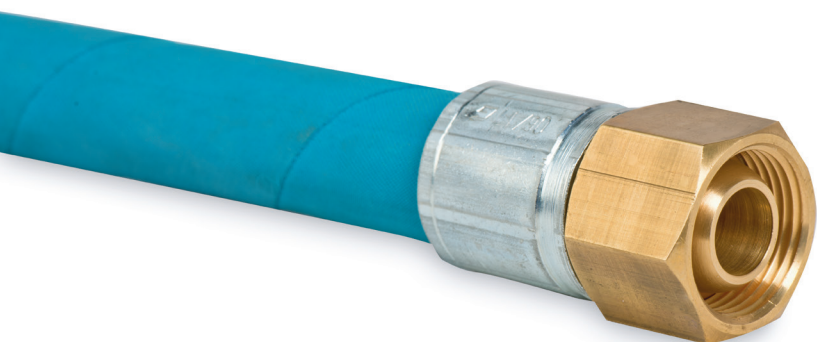

DIMENSIONS

Nominal size	DN 12	DN 16	DN 25	DN 31	DN 38
Inside (mm)	12.7	15.9	25,4	31,8	38,1
Outside (mm)	19.7	23.9	34,4	42,3	49,6

MEDIUM	Oxygen	Oxygen	Oxygen	Oxygen	Oxygen
---------------	--------	--------	--------	--------	--------

COLOR CODING	Blue	Blue	Blue	Blue	Blue
---------------------	------	------	------	------	------

WORKING PRESSURE (bar)	25	25	25	25	25
-------------------------------	----	----	----	----	----

TEST PRESSURE (bar)	50	50	50	50	50
----------------------------	----	----	----	----	----

MEDIUM TEMP. (°C)	-30 – 60	-30 – 60	-30 – 60	-30 – 60	-30 – 60
--------------------------	----------	----------	----------	----------	----------

WORKING TEMP. (°C)	-40 – 100	-40 – 100	-40 – 100	-40 – 100	-40 – 100
---------------------------	-----------	-----------	-----------	-----------	-----------

BEND RADIUS (mm)	70	90	150	190	240
-------------------------	----	----	-----	-----	-----

2SG HOSES

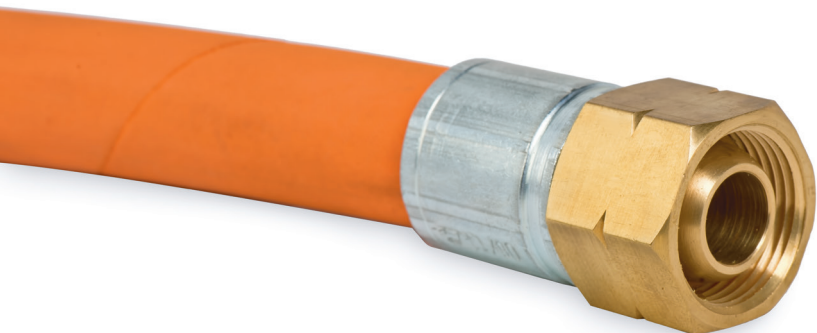

ITEM NO.	108353	108354	108355	108357
DIMENSIONS				
Nominal size	DN10	DN12	DN16	DN25
Inside (mm)	9.5	12.7	15.9	25.4
Outside (mm)	16.5	19.7	23.9	34.4
MEDIUM	CPM	CPM	CPM	CPM
COLOR CODING	Red	Red	Red	Red
WORKING PRESSURE (bar)	25	25	25	25
TEST PRESSURE (bar)	50	50	50	50
MEDIUM TEMP. (°C)	-30 – 60	-30 – 60	-30 – 60	-30 – 60
WORKING TEMP. (°C)	-40 – 100	-40 – 100	-40 – 100	-40 – 100
BEND RADIUS (mm)	60	70	90	150

2TE HOSES



ITEM NO.	105666	105667	105668	105669	105670
DIMENSIONS					
Nominal size	DN10	DN12	DN16	DN19	DN25
Inside (mm)	9.5	12.7	15.9	19	26.4
Outside (mm)	16.5	19.7	19.7	27	34.4
MEDIUM	Water & air	Water & air	Water & air	Water & air	Water & air
COLOR CODING	Black	Black	Black	Black	Black
WORKING PRESSURE (bar)	25	25	25	25	25
TEST PRESSURE (bar)	50	50	50	50	50
MEDIUM TEMP. (°C)	-30 – 60	-30 – 60	-30 – 60	-30 – 60	-30 – 60
WORKING TEMP. (°C)	-40 – 100	-40 – 100	-40 – 100	-40 – 100	-40 – 100
BEND RADIUS (mm)	60	70	90	110	150

3TE HOSES

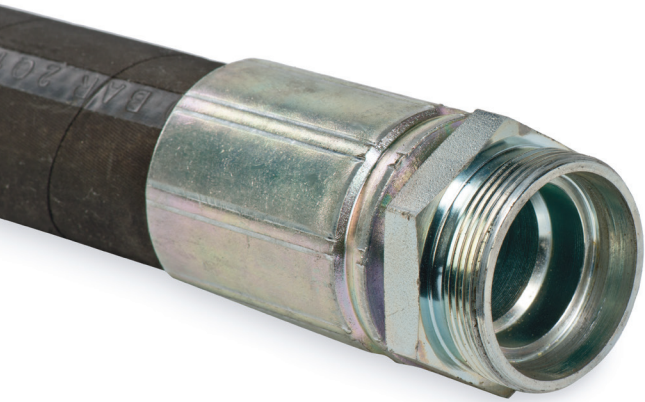

ITEM NO.	105671	105672
DIMENSIONS		
Nominal size	DN31	DN38
Inside (mm)	31.8	38.1
Outside (mm)	52.3	49.6
MEDIUM	Water & air	Water & air
COLOR CODING	Black	Black
WORKING PRESSURE (bar)	45	40
TEST PRESSURE (bar)	90	80
MEDIUM TEMP. (°C)	-30 – 60	-30 – 60
WORKING TEMP. (°C)	-40 – 100	-40 – 100
BEND RADIUS (mm)	190	240

PTFE HOSES

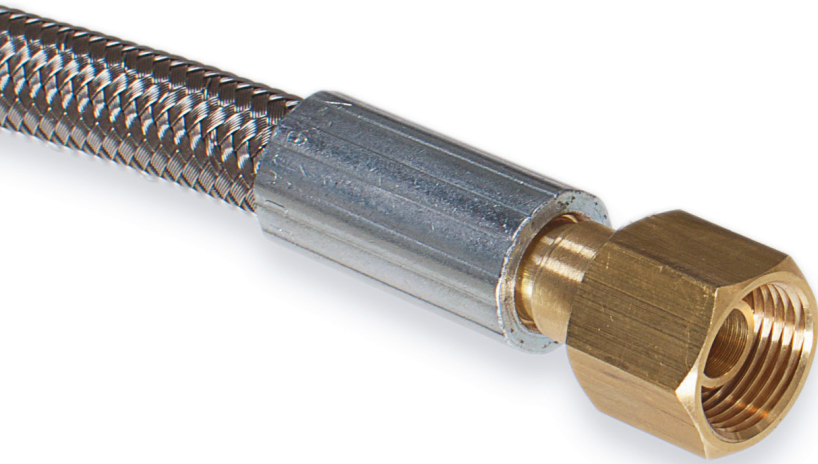

ITEM NO.	105675	105676	105677	105678	105679	105680
DIMENSIONS						
Nominal size	DN6	DN10	DN12	DN16	DN19	DN25
Inside (mm)	4.8 – 5.4	9.9 – 10.6	13 – 13.4	16.1 – 17.1	19.3 – 20.3	25.6 – 26.6
Outside (mm)	10 – 10.5	14.1 – 14.7	17.2 – 18.1	20 – 20.9	24.5 – 25.5	30.1 – 30.8
MEDIUM						
	All	All	All	All	All	All
COLOR CODING						
	Stainless steel	Stainless steel	Stainless steel	Stainless steel	Stainless steel	Stainless steel
WORKING PRESSURE (bar)						
	224	183	189	114	103	80
TEST PRESSURE (bar)						
	793	552	566	345	310	241
WORKING TEMP. (°C)						
	-70 – 260	-70 – 260	-70 – 260	-70 – 260	-70 – 260	-70 – 260
BEND RADIUS (mm)						
	85	135	165	195	225	305

MOBILE EQUIPMENT

Corti
Corti gas control panel

CORTI MOBILE EQUIPMENT

AMT Gega also offers a portable flame cutting machine. The AMT Gega Corti offers a high level of flexibility with regards to its area of use. The light and robust aluminium casing offers the perfect housing for the speed controller, operated via a potentiometer.

Cutting is carried out by AMT Gega flame cutters in the SB range, tried and tested over many years. These were optimised to be adapted to the requirements of a compact cutting system.

The Corti is guided by a special aluminium rail, which is divided into sections with a maximum length of 6 metres.

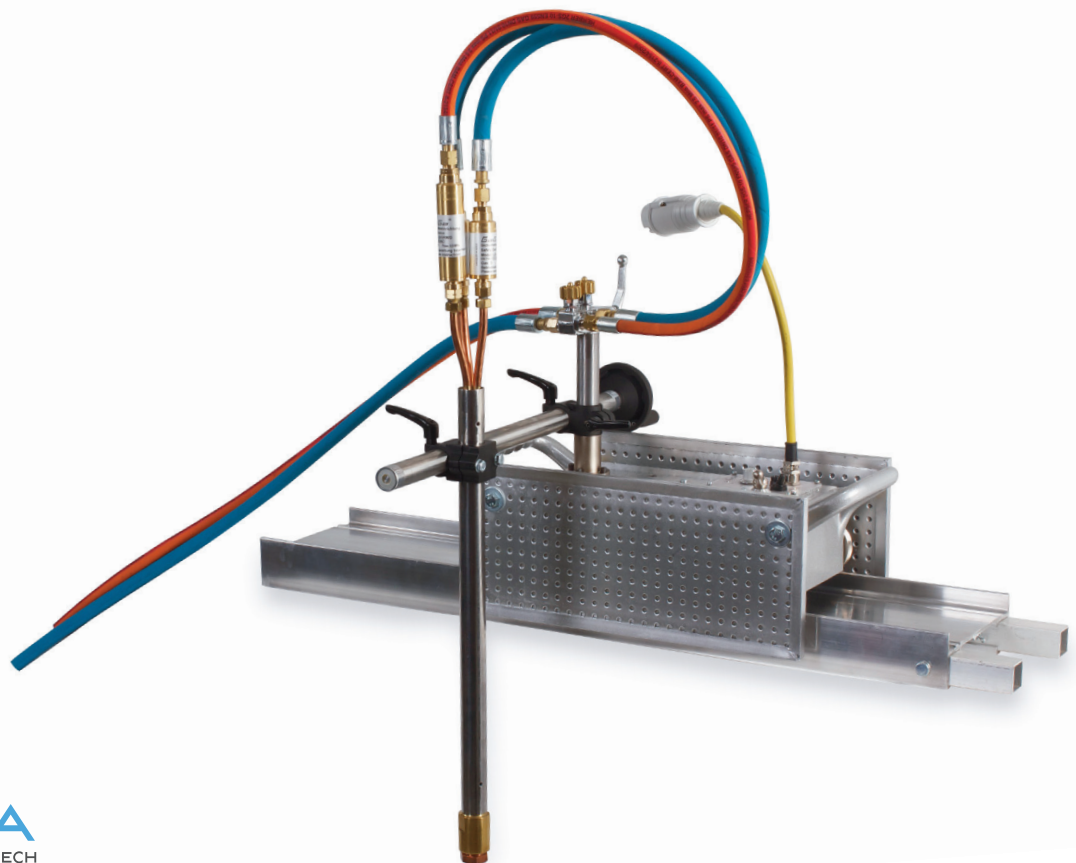

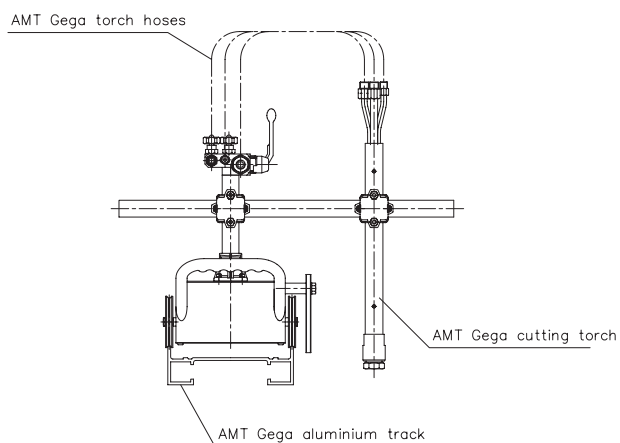

ITEM NO.	111122	112221
CONNECTION		
Voltage (V)	230	115
Compressed air	optional	optional
Oxygen	G 1/2"	UNF 7/8" CGA
Gas	G 3/8" LH	UNF 9/16" LH CGA
DIMENSIONS (mm)		
Track width	220	220
Height	~ 360	~ 360
Width	~ 550	~ 550
Length	~ 300	~ 300
ARM LENGTH (mm)	230 – 535	230 – 535
SPEED MAX. (mm/min)	500	500
WEIGHT (kg)	22	22
HEAT PROTECTION	optional	optional

GAS CONTROL PANEL MOBILE EQUIPMENT

AMT Gega also offers a portable flame cutting machine. The AMT Gega Corti offers a high level of flexibility with regards to your area of use. The light and robust aluminium casing offers the perfect housing for the speed controller operated via a potentiometer.

Cutting is carried out by AMT Gega flame cutters in the SB range, tried and tested over many years. These were optimised to be adapted to the requirements of a compact cutting system. The Corti is guided by a special aluminium rail, which is divided into sections with a maximum length of 6 metres.

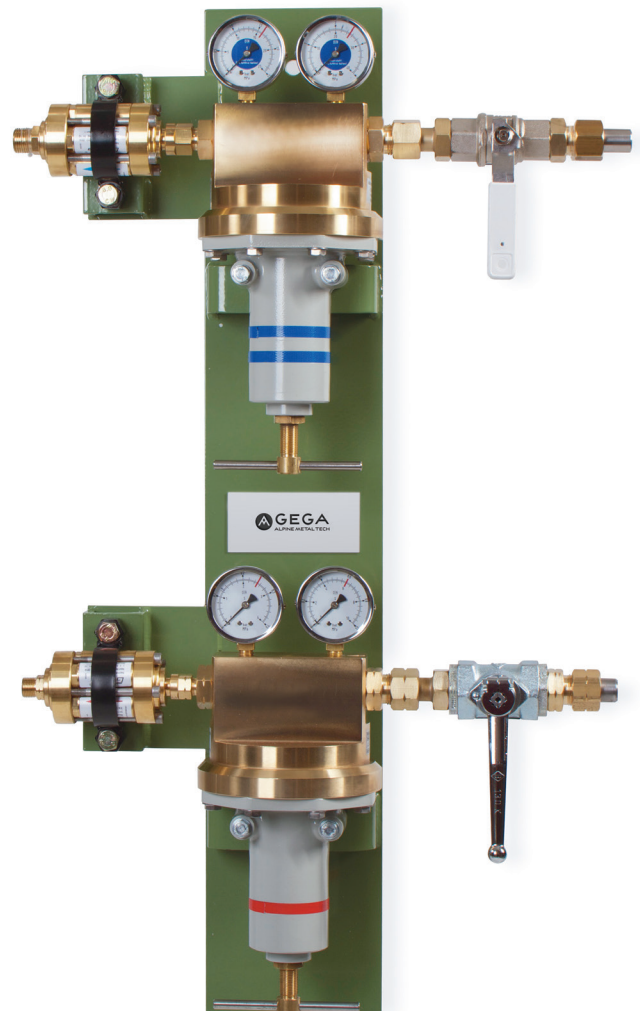

Gas control panel

ITEM NO.	109314	111364
CONNECTION		
Compressed air	–	G 1/2"
Oxygen	G 1/2" ; UNF 7/8" CGA	G 1/2" ; UNF 7/8" CGA
Gas	G 3/8" LH ; UNF 9/16" LH CGA	G 3/8" LH ; UNF 9/16" LH CGA
DIMENSIONS (mm)		
Height	850	850
Width	500	500
Length	165	165
WEIGHT (kg)	39	42
HEAT PROTECTION	optional	optional

ADDITIONAL EQUIPMENT

Powder equipment
Nozzle seat reamer
Measuring device
Repair kits / Gasket kits
Pressure gauge

POWDER EQUIPMENT ADDITIONAL EQUIPMENT

The autogenous process is conventionally limited to certain types of steel. In order to extend these limits, AMT Gega offers a powder system. By inserting Fe powder into the cutting jet, a temperature increase is generated, with which the processing of an extended product range is made possible.

The optionally available AMT Gega powder system is specially adapted to AMT Gega machines. By using sophisticated components within the system, a high process safety is achieved. Whether manual operation or automatic mode, an optimum powder flow is always provided. The AMT Gega Powder equipment consists of the AMT Gega Powderpot, AMT Gega Pinch valve, AMT Gega Powder Injector and AMT Gega Powder pipe clamp. Optionally, the powderflow can be designed in a double and a single outlet.

Feeding of iron powder into the cutting jet is facilitated via a tube running parallel to the torch. This tube is fitted in front of the torch regarding the cutting direction. The iron powder is fed through components positioned between the container for iron powder and the feed pipe. The container for iron powder is equipped with a level indicator. It can be filled manually either on the platform or at the machine, depending on its position.

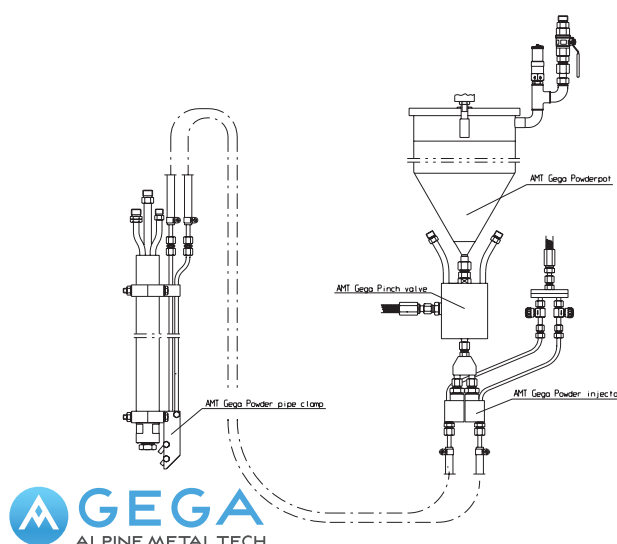

MAIN CHARACTERISTICS

Application: Cutting of stainless steel

Variations: Stationary & movable

Optional: Air dryer, powder container in front of the machine (for automatic refilling of the containers on the machine), alignment of the iron powder feed pipe at the torch according to the cutting direction (longitudinal resp. transversal)

Characteristics: Highest quality standard. Long lifetime. Well-developed ergonomics. Optimum safety (longitudinal resp. transversal)

GeGa Service: Planning, design and supply of the powder equipment, provision of spare parts, retrofitting of powder equipment on existing machines.

PRESSURE MEASURING DEVICE ADDITIONAL EQUIPMENT

Due to the varying structure of AMT Gega machines, there are also various line resistances. In order to measure the optimum pressure in any cutting system, measurement points are set up at defined positions. The necessary components for these measurement points are the available as AMT Gega pressure measuring devices. In the instance of torches, a measuring boss is integrated between the torch connection and the hose connection, facilitating reading and adjustment of the optimal torch pressure. In connection with the AMT Gega measuring coupling, this measurement point can remain permanently installed.



EU standard connection

ITEM NO.	103507	103508	103509	112481	112479	112480
MEDIUM	Heating oxygen	Cutting oxygen	CPM	Heating oxygen	Cutting oxygen	CPM
CONNECTION						
Inlet 1	G 3/8" M	G 1/2" M	G 1/2" LH M	G 3/4" M	G 1" M	G 1"LH M
Outlet 1	G 3/8" F	G 1/2" F	G 1/2" LH F	G 3/4" F	G 1" F	G 1"LH M
DIMENSIONS (mm)						
Height	180	180	180	180	180	185
Width	20	20	20	30	30	30
Length	72	82	82	110	116.5	116.5
APPLICABLE TORCHES						
SB 500 F	+	+	+			
SB 1200				+	+	+

US standard connection

ITEM NO.	112701	112831	112702
MEDIUM	Heating Oxygen	Cutting Oxygen	CPM
CONNECTION			
Inlet 1	UNF/JIC 1 1/16 M	UNF/JIC 1 1/16 M	UNF/JIC 7/8 M
Outlet 1	UNF/JIC 1 1/16 F	UNF/JIC 1 1/16 F	UNF/JIC 7/8 F
DIMENSIONS (mm)			
Height	185	185	181
Width	20	20	20
Length	110	110	90
APPLICABLE TORCHES			
SB 500 F	+	+	+
SB 1200			

NOZZLE SEAT REAMER ADDITIONAL EQUIPMENT

For the maintenance of torches, AMT Gega provides a tool to remill the nozzle seat, a great way of extending equipment lifetime after numerous nozzle changes.



ITEM NO.	110411	112267	111379	103304	110837
APPLICABLE TORCHES					
SB 500 F	+				
SBK 500 F	+				
SB 800 F		+			
SB 1200			+		
SHBA (S) 1280				+	
SHBA (S)-M(S) F	+				
MST 1500					+
MST 1200 CGA					+
SHF 100-F-1500					+

GASKET REPAIR SET ADDITIONAL EQUIPMENT

Several repair kits and gasket sets have been compiled for the maintenance of AMT Gega regulating units. The range starts with a basic set and goes right up to specially compiled sets for the various construction stages.

The scope of delivery includes seals and mechanically strained wearing components.

The components of the gasket set include special seals for the regulator type and a suitable O-ring set.

Please get in touch with our Life Cycle Management team to discuss maintenance by Gega specialists on site.



PRESSURE GAUGE ADDITIONAL EQUIPMENT

AMT Gega also has manual pressure measuring systems in the product range. The manometers are subject to strict requirements, which apply when dealing with oxygen and CPM. They are also particularly long lasting, due to the stable brass casing and the use of inspection glasses made of safety glass. The high-quality connections made of brass can be attached concentrically behind, or radially below.

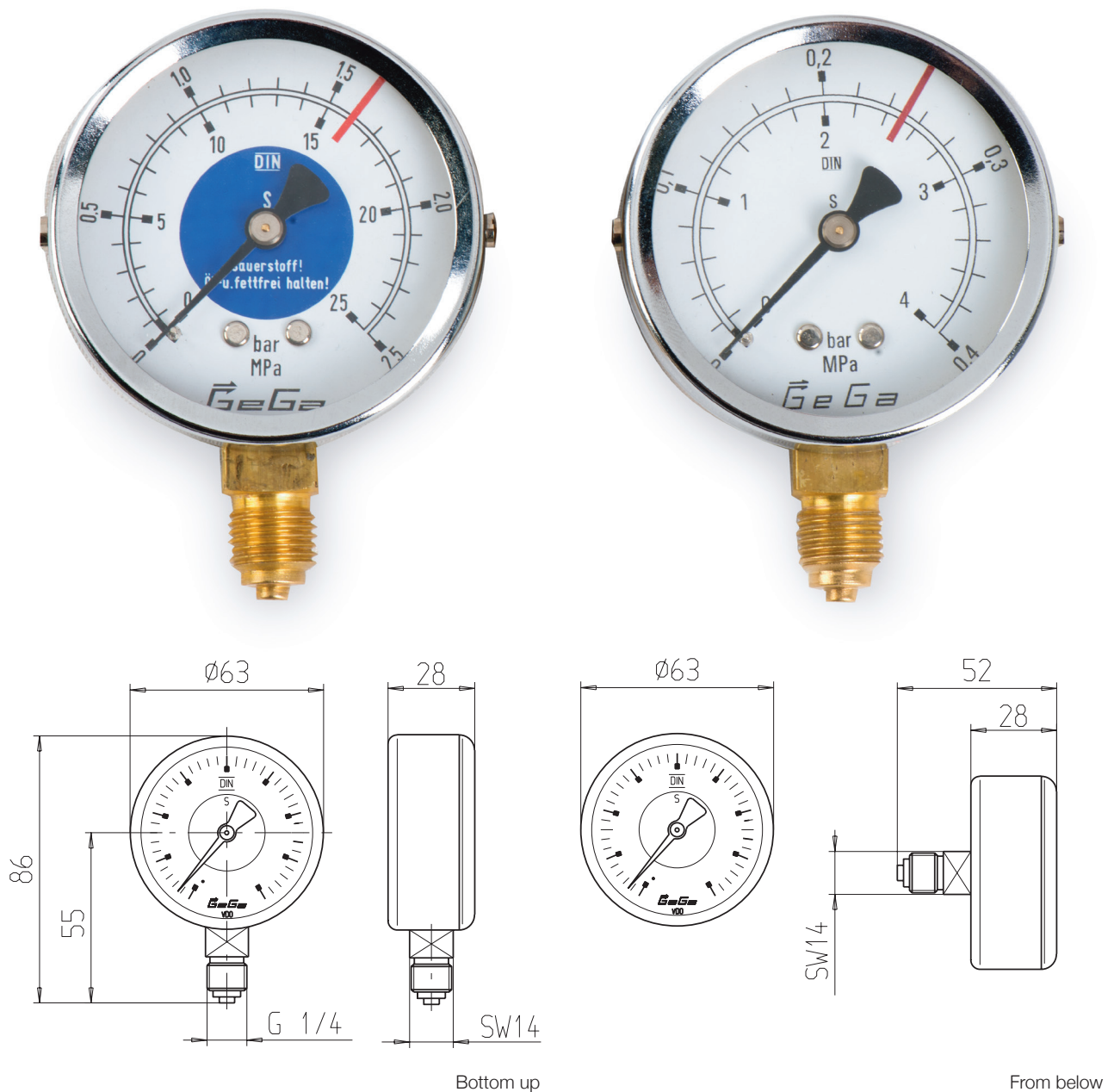

PRESSURE GAUGE / BOTTOM UP

ITEM NO.	103481	103482	103483	103484	103485
PRESSURE RANGE					
Pressure range (bar)	0 – 25	0 – 4	0 – 25	0 – 40	0 – 2.5
Pressure range (kg/cm ²)	–	–	–	–	–
Pressure range (PSI)	–	–	–	–	–
MEDIUM	Oxygen	Oxygen	Oxygen	Oxygen	CPM. water, air

PRESSURE GAUGE / BOTTOM UP

ITEM NO.	103486	103487	103498	103499	103500
PRESSURE RANGE					
Pressure range (bar)	0 – 4	0 – 10	–	–	–
Pressure range (kg/cm ²)	–	–	0 – 2.5	0 – 4	0 – 25
Pressure range (PSI)	–	–	–	–	–
MEDIUM	CPM, water, air	CPM, water, air	Oxygen	Oxygen	Oxygen

PRESSURE GAUGE / BOTTOM UP

ITEM NO.	103501	103502	103503	113891	113892
PRESSURE RANGE					
Pressure range (bar)	–	–	–	–	–
Pressure range (kg/cm ²)	0 – 2.5	0 – 4	0 – 10	–	–
Pressure range (PSI)	–	–	–	0 – 100	0 – 300
MEDIUM	CPM, water, air	CPM, water, air	CPM, water, air	Oxygen	Oxygen

PRESSURE GAUGE / FROM BELOW

ITEM NO.	103645	103646	103647	103648
PRESSURE RANGE				
Pressure range (bar)	0 – 4	0 – 25	0 – 40	0 – 2.5
MEDIUM	Oxygen	Oxygen	Oxygen	CPM, water, air

PRESSURE GAUGE / FROM BELOW

ITEM NO.	103649	103650	103651	103652
PRESSURE RANGE				
Pressure range (bar)	0 – 4	0 – 10	0 – 1	0 – 16
MEDIUM	CPM, water, air	CPM, water, air	CPM, water, air	CPM, water, air

SERVICE

MAINTENANCE & LIFECYCLE MANAGEMENT SERVICE

We are in a pretty tough business. No doubt about it. Day in and day out, we work under the most gruelling circumstances: Delivering consistency. Speed. Precision. In sweltering heat and pitch dark. The reason we are on top? Because we are tougher. As an additional option, you can also have your regulating stations maintained and repaired by AMT Gega technicians.



Gega machines and components are renowned for their extraordinary long lifetime. This makes spending an extra thought on maintenance and service all the more worthwhile. We are proud to support our clients' daily operations with efficient replacement schemes to ensure maximum equipment readiness. Our experts stand by with legendary in-depth knowledge and years of experience.

Over 40 subsidiaries around the globe ensure that a Gega specialist can join you on site whenever the situation requires immediate attention. Once the end of a life cycle is approached, Gega will assist you with the planning of refurbishment, temporary replacement and back-up of entire machines.

READY TO GO? SERVICE

Get in touch with one of our service engineers to map out a maintenance schedule that best suits your operational requirements. These are the benefits of working with Gega Lifecycle Management:



Commission faster

Reaching maximum performance of newly installed torch cutting equipment can take months. Obtain perfect results faster with the help of Gega experts on site, helping you to find the correct setup for your equipment.



Be prepared

Keeping your equipment in optimal operational conditions is easy with scheduled or on-demand Gega maintenance. Gega lifecycle management will assist with planning of shipment, exchange-patterns and plant down-times. Experienced service engineers on site will identify wear and tear early and consult on an individual lifecycle strategy.



Evolve

Your business evolves. So does Gega equipment. Get ready for the next challenge in your market by re-fitting your machines to accommodate new material qualities or sizes. Time-proven equipment may show hidden potential in terms of efficiency or speed, so make sure to check back with us on a regular basis to assess your operational setup.

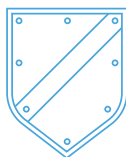

Stay safe

“Made in Germany” is a token for the highest standards in reliability and build quality. Gega lifecycle management will assist you in creating and maintaining DIN EN14753 compliant work environments for maximum safety. Get in touch for the development and implementation of workplace safety guidelines suited to your company’s individual requirements.

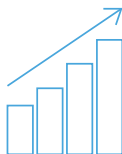

Reach peak performance

“It’s a Gega!” is the battle cry for unmatched performance in autogenous technology. Engage us to put over 40 years of industry experience to work when it comes to optimizing your workflows, fine-tuning equipment setups and making best use of innovations like Gega SHEL or Gega STD nozzles for cutting faster, thicker and more accurately.



Drive media cost down

Are you using resources as economically as possible? Talk to your Gega service partner to become smarter with media consumption and operational costs. From developing improved pilot flame logics to overhauling entire cutting workflows, Gega has devised numerous strategies that help businesses run more efficiently.



Become an expert

Join us for training workshops to receive in-depth briefings on all types of Gega equipment. Gega has a long history of hosting engineers and technicians from around the globe or setting up training sessions on site. Together, we will lay a foundation of robust knowledge for maintenance and trouble-shooting and help you get small jobs done independently.



Have peace of mind

If your business never sleeps, having a backup can be crucial. This is why Gega supplies secondary machines to a growing number of plants with a continuous casting environment. Backup units can be used in breakdown settings, for shut down-free maintenance jobs and to test and implement technology upgrades with minimum impact on daily business.

Alpine Metal Tech Germany GmbH
Kochstraße 2
66763 Dillingen/Saar
Tel.: +49 6831 89446-0
E-Mail: germany@alpinemetaltech.com
Web: www.alpinemetaltech.com

